

■ FEATURES

- Low profile package
- Ideal for automated placement
- Glass passivated chip junction
- High forward surge capability
- Fast reverse recovery time
- Meets MSL level 1, per J-STD-020, LF maximum peak of 260 °C

■ TYPICAL APPLICATIONS

For use in high frequency rectification of power supplies, inverters, converters, and freewheeling diodes for consumer, and telecommunication.

■ MECHANICAL DATA

- **Package:** SMAF
Molding compound meets UL 94 V-0 flammability rating, RoHS-compliant, halogen-free
- **Terminals:** Tin plated leads, solderable per J-STD-002 and JESD22-B102
- **Polarity:** Cathode line denotes the cathode end

■ MAXIMUM RATINGS (T_a=25°C Unless otherwise specified)

PARAMETER	SYMBOL	UNIT	F1AFS	F1BFS	F1DFS	F1GFS	F1JFS	F1KFS	F1MFS
Device marking code			F1AFS	F1BFS	F1DFS	F1GFS	F1JFS	F1KFS	F1MFS
Repetitive peak reverse voltage	VRRM	V	50	100	200	400	600	800	1000
Average rectified output current @60Hz sine wave, resistance load, TL (Fig.1)	I _O	A	1.0						
Surge(non-repetitive)forward current @60Hz half-sine wave, 1 cycle, T _a =25°C	I _{FSM}	A	30						
Storage temperature	T _{stg}	°C	-55~+150						
Junction temperature	T _j	°C	-55~+150						

■ ELECTRICAL CHARACTERISTICS (T_a=25°C Unless otherwise specified)

PARAMETER	SYMBOL	UNIT	TEST CONDITIONS	F1AFS	F1BFS	F1DFS	F1GFS	F1JFS	F1KFS	F1MFS
Maximum instantaneous forward voltage drop per diode	V _F	V	IFM=1.0A	1.3						
Maximum reverse recovery time	t _r	ns	I _F =0.5A, I _R =1.0A, I _r =0.25A	150			250		500	
Maximum DC reverse current at rated DC blocking voltage per diode @ VRM=VRRM	I _{RRM}	μA	T _a =25°C	5.0						
			T _a =125°C	100						

■ THERMAL CHARACTERISTICS (T_b=25°C Unless otherwise specified)

PARAMETER	SYMBOL	UNIT	F1AFS	F1BFS	F1DFS	F1GFS	F1JFS	F1KFS	F1MFS
Thermal resistance	R _{θJ-A} ⁽¹⁾	°C/W	70 ⁽¹⁾						
	R _{θJ-L} ⁽¹⁾		25 ⁽¹⁾						

Note:

(1) Thermal resistance from junction to ambient and from junction to lead mounted on P.C.B. with 0.2" x 0.2" (5.0 mm x 5.0 mm) copper pad areas

■ **CHARACTERISTICS (Typical)**

FIG.1: Io-TL Curve

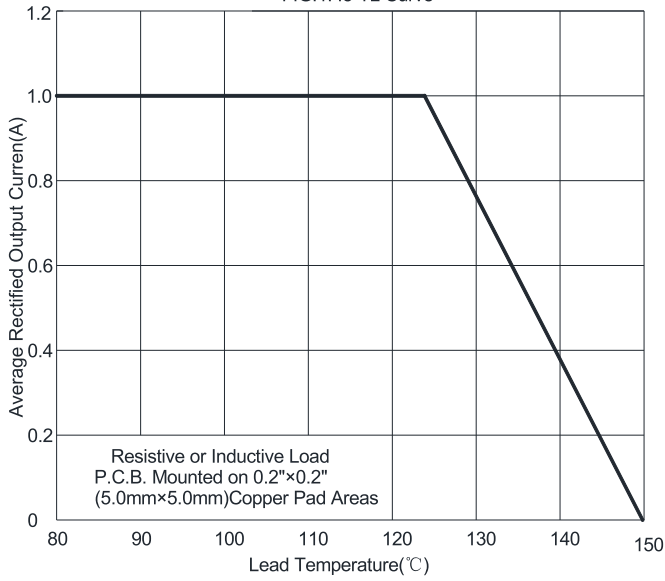

FIG2: Surge Forward Current Capability

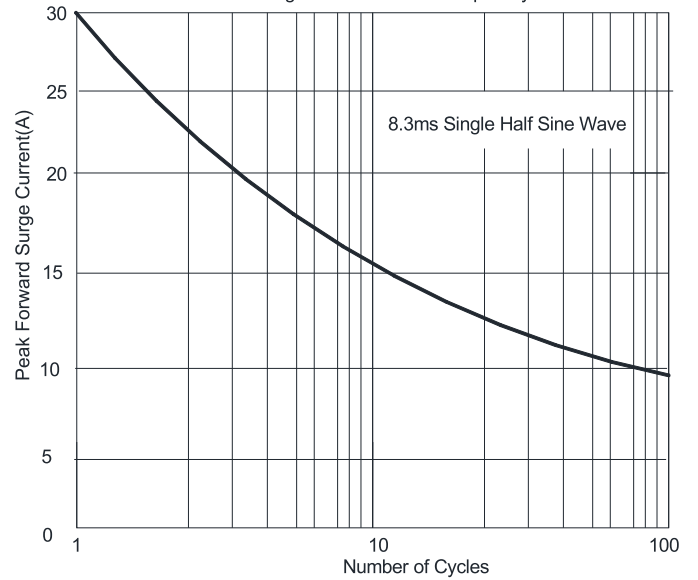

FIG3: Forward Voltage

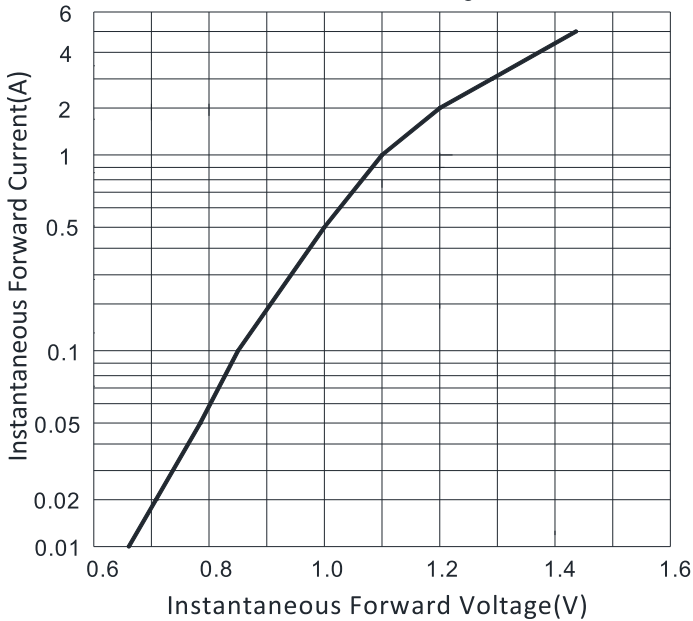
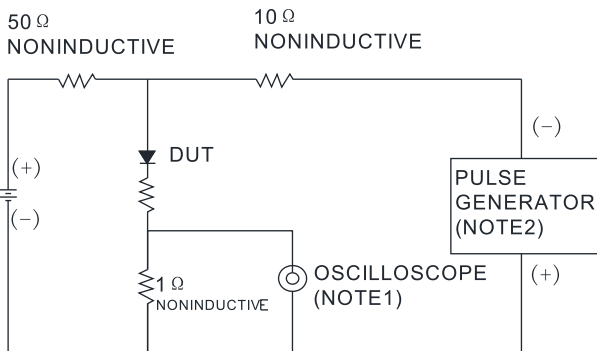
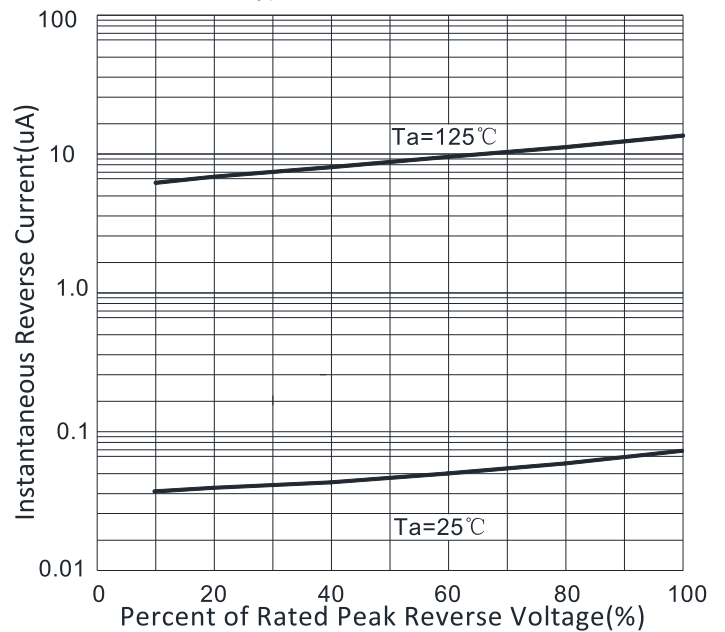
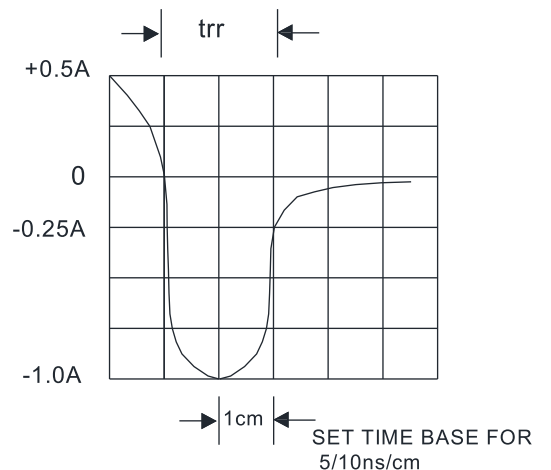

FIG4: Typical Reverse Characteristics



NOTES:
1. Rise Time=7ns max. Inpot Impedance=1MΩ 22pf
2. Rise Time=10ns max. Source Impedance=50Ω



■ PURCHASING INFORMATION

PREFERED P/N	PACKING CODE	UNIT WEIGHT(g)	MINIMUM PACKAGE(pcs)	INNER BOX QUANTITY(pcs)	OUTER CARTON QUANTITY(pcs)	DELIVERY MODE
F1AFS-F1MFS	XO7	Approximate 0.034	3000	12000	96000	7" reel
F1AFS-F1MFS	Omit for Standard	Approximate 0.034	10000	20000	160000	13" reel

■ OUTLINE INFORMATION

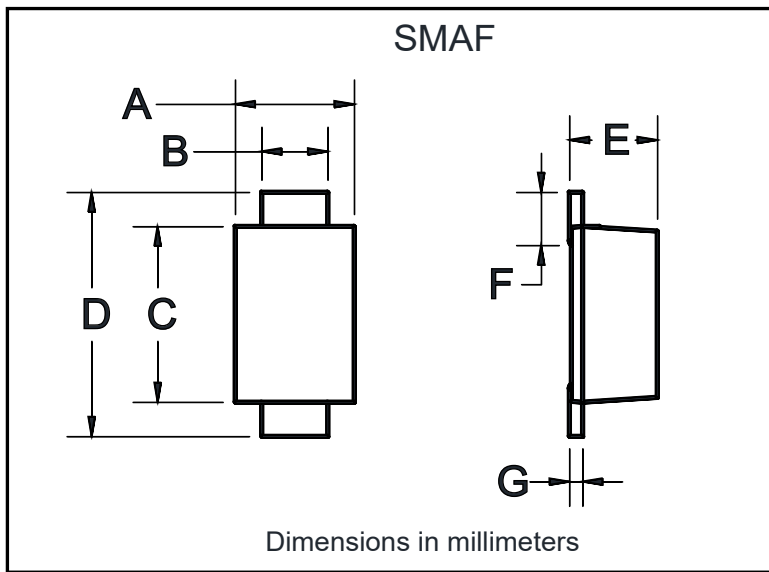

SMAF		
Dim	Min	Max
A	2.40	2.80
B	1.35	1.45
C	3.40	3.60
D	4.40	4.80
E	1.05	1.25
F	0.50	1.00
G	0.15	0.22

■ SUGGESTED PAD LAYOUT

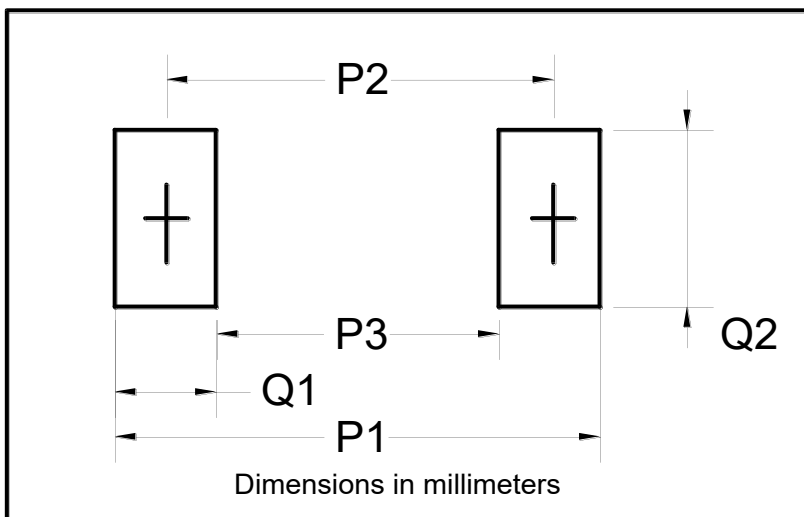

SMAF	
Dim	Millimeters
P1	6.50
P2	4.00
P3	1.50
Q1	2.50
Q2	1.70