

The Ultra high surge current type JVT-U series are specifically designed for Ultra high transient surge suppression. They are radial leaded varistors (MOVs or VDRs) designed to be the continuously used across AC line primary or DC circuit.

Operating Temperature -40°C~+125°C

■ **RECOGNITION** : made for RFE by UL shop Joyin



Agency	File Number	Monogram
UL/cUL	E325508	
VDE	Certificate No. 005937	
CQC	CQC07001019159 /9161/9162/9163/9164	

■ **CHARACTERISTICS & RATINGS**

Part Number	Varistor Voltage at 0.1mA		Maximum Allowable Voltage		Maximum Clamping Voltage		Withstanding Surge Current (8/20µs)	Nominal Discharge Current (8/20µs)	Rated Wattage	Energy (10/1000µs)
	DC (V)	Tolerance	AC rms (V)	DC (V)	V@ ic (V)	ic (A)				
JVT07U181K65***	180	±10%	115	150	300	10	1800	1	0.25	19
JVT07U201K65***	200		130	170	340					21
JVT07U221K65***	220		140	180	360					23
JVT07U241K65***	240		150	200	395					25
JVT07U271K65***	270		175	225	455					28
JVT07U301K65***	300		195	250	505					32
JVT07U331K65***	330		210	275	550					34
JVT07U361K65***	360		230	300	595					37
JVT07U391K65***	390		250	320	650					40
JVT07U431K65***	430		275	350	710					46
JVT07U471K65***	470		300	385	775					49
JVT07U511K65***	510		320	418	842					54
JVT07U561K65***	560		350	460	920					55
JVT07U621K65***	620		385	505	1025					59
JVT07U681K65***	680		420	560	1120					62
JVT07U751K65***	750		460	615	1240					66
JVT07U781K65***	780		485	640	1290					68
JVT07U821K65***	820	510	670	1355	71					

*** Replace with Lead & Packaging code

■ 7mm PULSE LIFETIME RATINGS

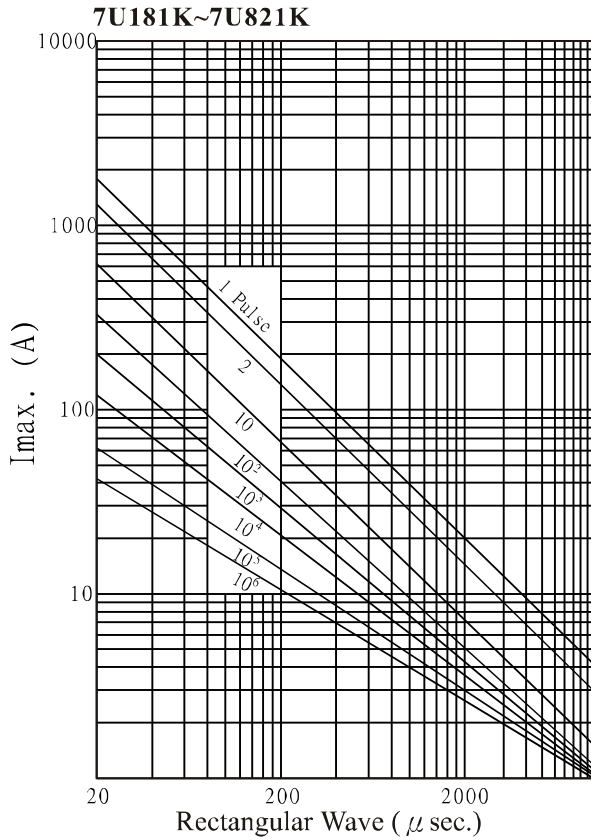

■ 7mm V-I CHARACTERISTIC CURVE

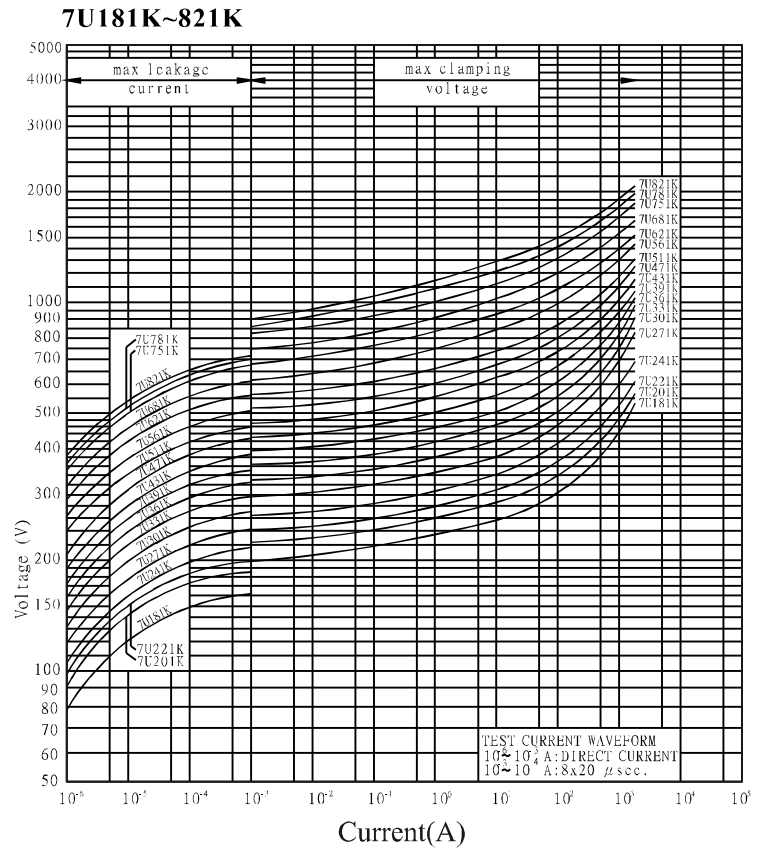

■ CURENT - VOLTAGE CHARACTERISTICS

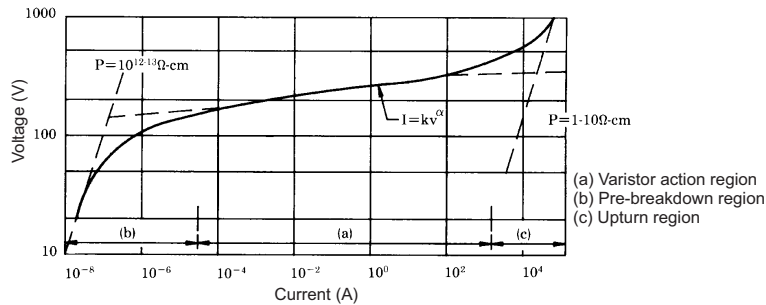

Operating & Storage Temperature Range : -40°C to +85°C
Temperature Coefficient of Voltage : 0~0.05% / °C max.

■ PART NUMBER EXAMPLE

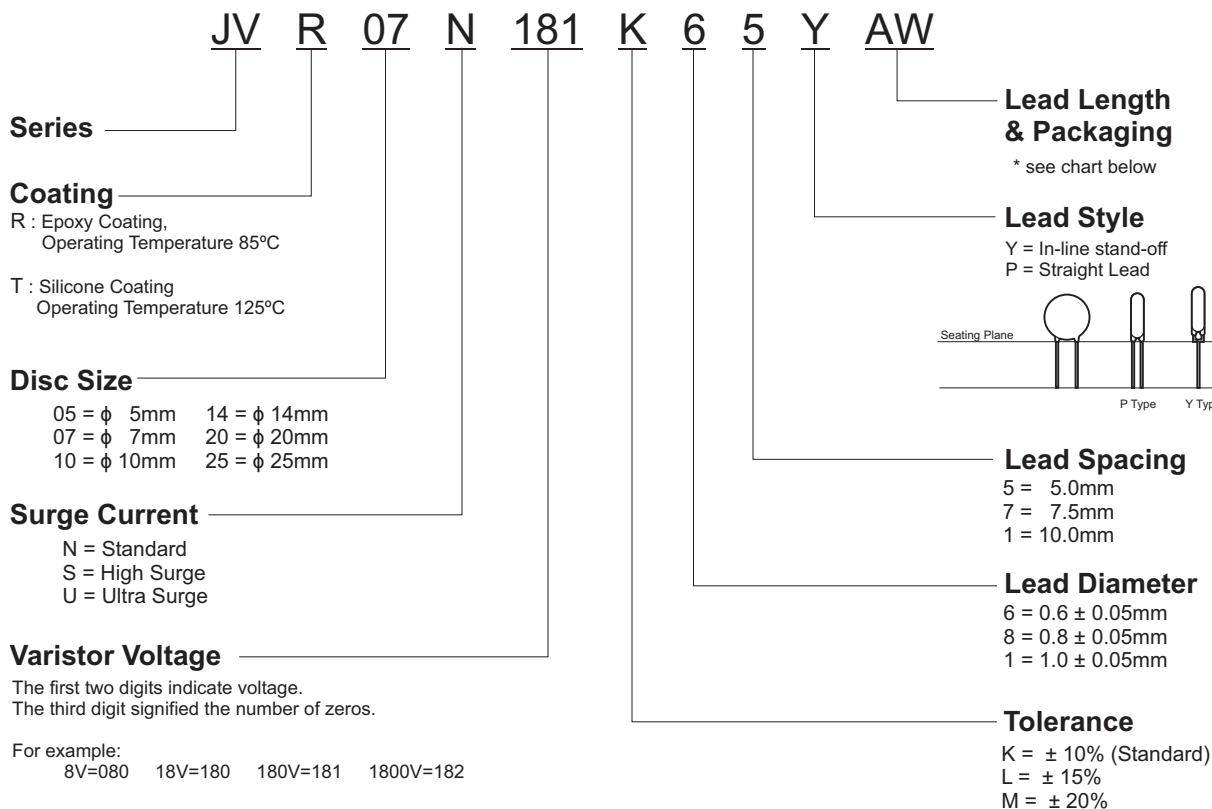

■ LEAD LENGTH & PACKAGING

Stand-off Formed (Y Type)

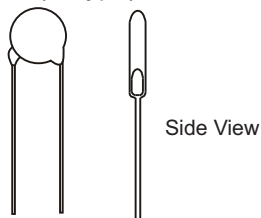

Straight Lead (P Type)

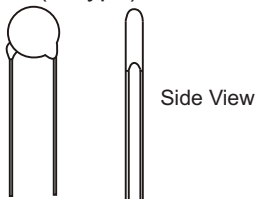

Lead Type	Code	Dimension	Package
Y Type Leads	50	L = 5 ± 1 mm	Bulk
	U4	L = 24mm min.	Bulk
	AW	H ₀ = 16mm	Ammo
	RW	H ₀ = 16mm	Reel
P Type Leads	50	L = 5 ± 1 mm	Bulk
	U5	L = 25mm min.	Bulk
	AY	H ₀ = 20mm	Ammo
	RY	H ₀ = 20mm	Reel

* H₀ see the drawing on page 5

■ **LEAD STYLES & DIMENSIONS (mm)**

Stand-off Formed
(Y Type)

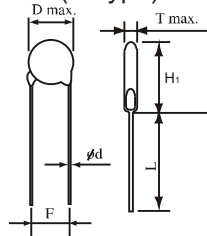

Straight Lead
(P Type)

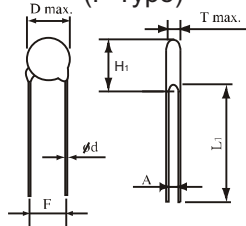

Diameter	5mm	7mm	10mm	14mm	20mm
D max	7.5	9.0	12.5	16.5	23.0
d ± 0.05	0.6	0.6	0.8	0.8	1.0
F ± 1.0	5.0	5.0	7.5	7.5	10.0
H max.	11.0	13.0	18/*19	22/*23	28/*29
L1 max.	25.0	25.0	25.0	25.0	25.0
L min.	24.0	24.0	24.0	24.0	24.0

* Just for 182K

Table of T & H1 max, A ± 0.8

Diameter	5mm			7mm			10mm			14mm			20mm		
	T	A	H1	T	A	H1	T	A	H1	T	A	H1	T	A	H1
180M	4.5	0.8	10.5	4.5	0.8	12	4.9	0.8	15.5	5	0.9	19.5	---	---	---
220M/L	4.5	0.9	10.5	4.5	0.9	12	4.9	0.9	15.5	5	1	19.5	5.3	1	26.5
270M/K	4.7	0.9	10.5	4.7	0.9	12	5.1	0.9	15.5	5.2	1.1	19.5	5.4	1.1	26.5
330M/K	4.7	1	10.5	4.7	1	12	5.1	1	15.5	5.2	1.2	19.5	5.4	1.2	26.5
390L/K	4.7	1.2	10.5	4.7	1.2	12	5.1	1.2	15.5	5.2	1.4	19.5	5.4	1.4	26.5
470L/K	5	1.2	10.5	5	1.2	12	5.5	1.2	15.5	5.6	1.4	19.5	5.6	1.4	26.5
560L/K	5	1.4	10.5	5	1.4	12	5.5	1.4	15.5	5.6	1.6	19.5	5.6	1.6	26.5
680L/K	5.5	1.7	10.5	5.5	1.7	12	6	1.7	15.5	6.1	1.9	19.5	6.1	1.9	26.5
820K	3.8	0.8	10.5	3.8	0.8	12	4.3	0.8	15.5	4.4	1	19.5	5	1.1	26.5
101K	3.9	0.8	10.5	3.9	0.8	12	4.4	0.8	15.5	4.5	1	19.5	5.1	1.2	26.5
121K	4.1	0.9	10.5	4.1	0.9	12	4.5	0.9	15.5	4.6	1.1	19.5	5.3	1.3	26.5
151K	4.5	1.2	10.5	4.5	1.2	12	4.9	1.2	15.5	5.1	1.4	19.5	5.6	1.6	26.5
181K	4.1	1	10.5	4.1	1	12	4.5	1	15.5	4.7	1.2	19.5	5.2	1.4	26.5
201K	4.2	1	10.5	4.2	1	12	4.6	1	15.5	4.8	1.2	19.5	5.3	1.47	26.5
221K	4.3	1.1	10.5	4.3	1.1	12	4.7	1.1	15.5	4.9	1.3	19.5	5.4	1.5	26.5
241K	4.4	1.1	10.5	4.4	1.3	12	4.8	1.3	15.5	5	1.5	19.5	5.5	1.7	26.5
271K	4.6	1.3	10.5	4.6	1.4	12	5	1.4	15.5	5.2	1.5	19.5	5.7	1.9	26.5
301K	4.8	1.3	10.5	4.8	1.5	12	5.2	1.6	15.5	5.4	1.7	19.5	5.9	2.1	26.5
331K	4.9	1.3	10.5	4.9	1.5	12	5.3	1.6	15.5	5.5	1.7	19.5	6	2.1	26.5
361K	5.1	1.8	10.5	5.1	1.9	12	5.5	1.9	15.5	5.7	2.1	19.5	6.2	2.3	26.5
391K	5.3	2	11	5.3	2	12.5	5.7	2.2	16	5.9	2.2	20	6.4	2.4	26.5
431K	6.1	2.1	11	6.1	2	12.5	6.5	2.5	16	6.7	2.5	20	7.2	2.7	26.5
471K	6.4	2.2	11	6.4	2.3	12.5	6.8	2.6	16	7	2.7	20	7.5	2.9	27
511K	6.6	2.5	11.5	6.6	2.5	13	7	3.1	16.5	7.2	3.1	20.5	7.7	3.3	27
561K	6.9	2.8	11.5	6.9	2.8	13	7.3	3.4	16.5	7.5	3.4	20.5	8	3.6	27
621K	7.2	3.1	11.5	7.2	3.1	13	7.6	4	16.5	7.8	3.8	20.5	8.3	4.1	27
681K	7.5	3.4	11.5	7.5	3.4	13	8	4.4	16.5	8.2	4.1	20.5	8.7	4.4	27
751K	7.9	3.7	11.5	7.9	3.7	13	8.4	4.4	16.5	8.6	4.3	20.5	9.1	4.5	27
781K	---	---	---	8.1	3.9	13	8.6	4.6	16.5	8.8	4.6	20.5	9.3	4.8	27
821K	---	---	---	8.3	4.1	13	8.8	4.6	16.5	9	4.6	20.5	9.5	4.8	27
911K	---	---	---	---	---	---	9.4	5.4	16.5	9.6	5.4	20.5	10.1	5.7	27
102K	---	---	---	---	---	---	9.9	5.4	16.5	10.1	5.6	20.5	10.7	5.8	27
112K	---	---	---	---	---	---	10.5	5.7	16.5	10.7	6.1	20.5	11.2	6.3	27
122K	---	---	---	---	---	---	10.9	6.3	17	10.9	6.7	21	11.3	6.9	27.5
142K	---	---	---	---	---	---	11.9	7.4	17.5	11.9	7.8	21.5	12.8	8	28
162K	---	---	---	---	---	---	13.1	8.6	18	13.1	9	22	13.7	9.2	28.5
182K	---	---	---	---	---	---	14.3	9.8	18.5	14.3	10.2	22.5	14.7	10.4	29

■ TAPING SPECIFICATIONS

1/2" pitch

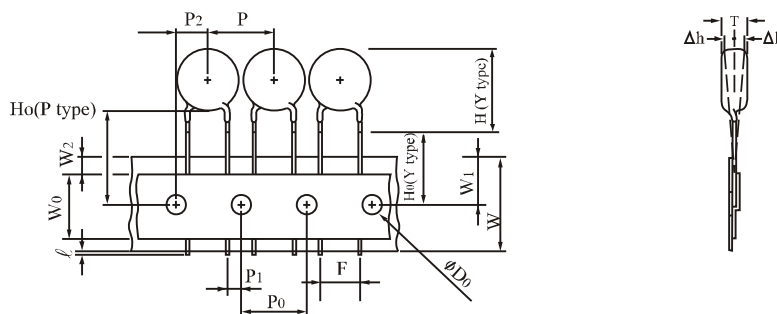

1.0" pitch

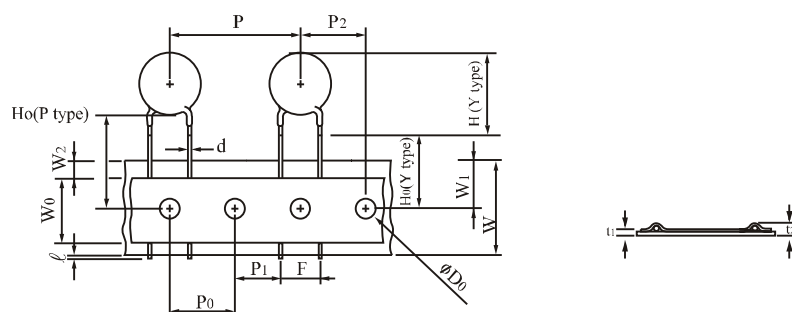

Symbols	Item	5 / 7 mm	10 / 14mm	20mm
	Cut out length	1.1 mm max.	1.1 mm max.	
H (Y Type)	Height of Top	See H Max. Table on page 4		
Ho (Y Type)	Height to seating plane	16.0 ± 0.5mm (*±1.0mm)	16.0 ± 0.5mm (*±1.0mm)	
Ho (P Type)	Height of component from hole center	16.0 ~ 21.0 mm	16.0 ~ 21.0 mm	
Δ h	Front to back deviation	0 ± 2.0 mm	0 ± 2.0 mm	
W	Carrier tape width	18.0 ^{+1.0} / _{-0.5} mm	18.0 ^{+1.0} / _{-0.5} mm	
W0	Hold down tape width	10.0mm	10.0mm	
W1	Sprocket hole position	9.0 ^{+0.75} / _{-0.5} mm	9.0 ^{+0.75} / _{-0.5} mm	
W2	Adhesive tape position	3.0 mm max.	3.0 mm max.	
F	Component head spacing	5.0 ^{+0.8} / _{-0.2} mm	7.5 ^{+0.8} / _{-0.2} mm	10 ^{+0.8} / _{-0.2} mm
P	Pitch of component	12.7 ± 1.0 mm	25.4 ± 1.0 mm	
P0	Sprocket hole pitch	12.7 ± 0.3 mm	12.7 ± 0.3 mm	
P1	Lead length from hole center to lead	3.85 ± 0.7 mm	8.95 ± 0.7 mm	7.7 ± 0.7 mm
P2	Length from hole center to disk center	6.35 ± 1.3 mm	12.7 ± 1.3 mm	
D0	Sprocket hole diameter	4.0 ± 0.2 mm	4.0 ± 0.2 mm	
d	Lead wire diameter	0.6 ± 0.05 mm	0.8 ± 0.05 mm	1.0 ± 0.05 mm
T	Disk thickness	See Table of T Max. on page 4		
t1	Total thickness tape	0.7 ± 0.05 mm	0.7 ± 0.05 mm	
t2	Total thickness	1.6 mm max.	1.8 mm max.	

* for manual line

■ **PACKAGING**

in mm

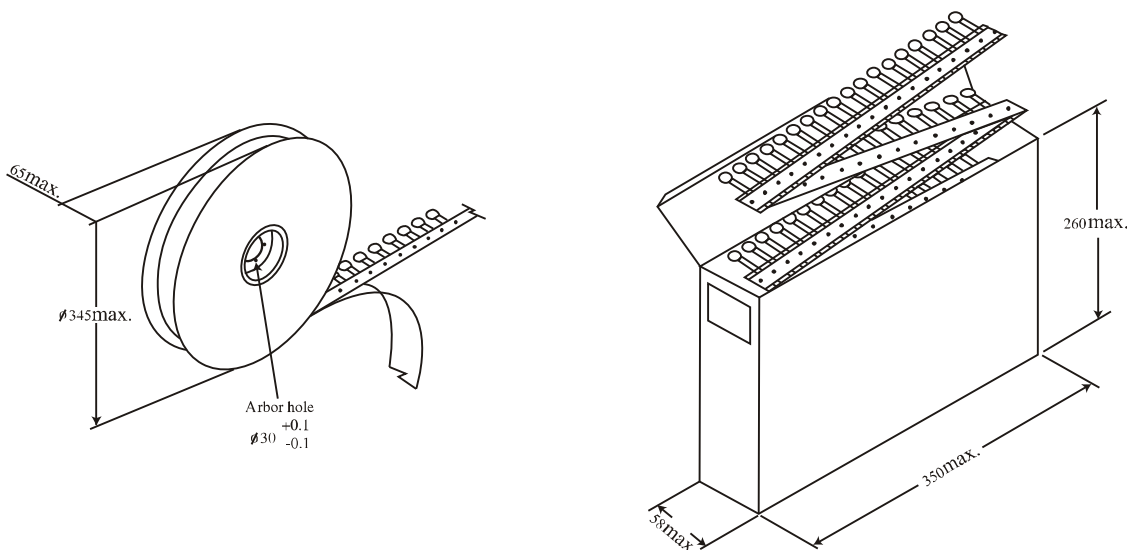

Quantity per Packing Unit

in Pcs

Series Part No.	5mm			7mm			10mm			14mm			20mm		
	Bulk (box)	Reel	Ammo	Bulk (box)	Reel	Ammo	Bulk (box)	Reel	Ammo	Bulk (box)	Reel	Ammo	Bulk (box)	Reel	Ammo
180M ~ 470K	5000	1500	1500	5000	1500	1500	2500	1000	500	1500	750	500	750	500	500
560K ~ 680K	5000	1500	1000	5000	1500	1000	2500	1000	500	1500	750	500	750	500	500
820K ~ 391K	5000	1500	1500	5000	1500	1500	2500	1000	500	1500	750	500	750	500	500
431K ~ 471K	5000	1500	1000	5000	1000	1000	2000	750	500	1500	750	500	750	500	500
511K ~ 821K	4000	1000	1000	4000	1000	1000	1500	500	500	750	500	500	450	500	500
911K ~ 122K	---	---	---	---	---	---	1500	500	350	750	500	350	450	---	---
142K ~ 182K	---	---	---	---	---	---	750	---	---	450	---	---	300	---	---

Packaging	Bulk (box)	Reel	Reel (14mm, 20mm)	Ammo (5mm, 7mm)	Ammo (10mm, 14mm)	Ammo (20mm)
Box size (mm)	290*155*110	350*350*105	346*346*72	335*245*43	347*246*50	348*255*60
Carton size (mm)	328*310*250	370*370*590	370*370*468	515*354*258	515*364*246	535*365*275
One carton with	4 boxes	5 boxes (10 reels)	6 boxes (6 reels)	10 boxes	8 boxes	8 boxes