

## ■ FEATURES

- Low profile package
- Ideal for automated placement
- Glass passivated chip junction
- High forward surge capability
- Super fast reverse recovery time
- Meets MSL level 1, per J-STD-020, LF maximum peak of 260 °C

## ■ TYPICAL APPLICATIONS

For use in high frequency rectification of power supplies, inverters, converters, and freewheeling diodes for consumer, and telecommunication.

## ■ MECHANICAL DATA

- **Package:** SMAF  
Molding compound meets UL 94 V-0 flammability rating, RoHS-compliant, halogen-free
- **Terminals:** Tin plated leads, solderable per J-STD-002 and JESD22-B102
- **Polarity:** Cathode line denotes the cathode end

## ■ MAXIMUM RATINGS (Ta=25°C Unless otherwise specified)

PARAMETER	SYMBOL	UNIT	H2AF	H2BF	H2DF	H2GF	H2JF	H2KF	H2MF
Device marking code			H2AF	H2BF	H2DF	H2GF	H2JF	H2KF	H2MF
Repetitive peak reverse voltage	VRRM	V	50	100	200	400	600	800	1000
Average rectified output current @60Hz sine wave, resistance load, TL (Fig.1)	IO	A	2.0						
Surge(non-repetitive)forward current @60Hz half-sine wave,1 cycle, Ta=25°C	IFSM	A	50						
Storage temperature	Tstg	°C	-55~+150						
Junction temperature	Tj	°C	-55~+150						

## ■ ELECTRICAL CHARACTERISTICS (Ta=25°C Unless otherwise specified)

PARAMETER	SYMBOL	UNIT	TEST CONDITIONS	H2AF	H2BF	H2DF	H2GF	H2JF	H2KF	H2MF
Maximum instantaneous forward voltage drop per diode	VF	V	IFM=2.0A	1.0			1.3	1.7		
Maximum reverse recovery time	tr	ns	IF=0.5A,IR=1.0A, IR=0.25A	50				75		
Maximum DC reverse current at rated DC blocking voltage per diode @ VRM=VRRM	IRRM	µA	Ta=25°C	5.0						
			Ta=125°C	100						

## ■ THERMAL CHARACTERISTICS (Ta=25°C Unless otherwise specified)

PARAMETER	SYMBOL	UNIT	H2AF	H2BF	H2DF	H2GF	H2JF	H2KF	H2MF
Typical Thermal resistance	RθJ-A <sup>(1)</sup>	°C/W	70 <sup>(1)</sup>						
	RθJ-L <sup>(1)</sup>		20 <sup>(1)</sup>						

**Note:**  
(1) Thermal resistance from junction to ambient and from junction to lead mounted on P.C.B. with 0.2" x 0.2" (5.0 mm x 5.0 mm) copper pad areas

### CHARACTERISTICS (TYPICAL)

FIG.1: I<sub>o</sub>-TL Cure

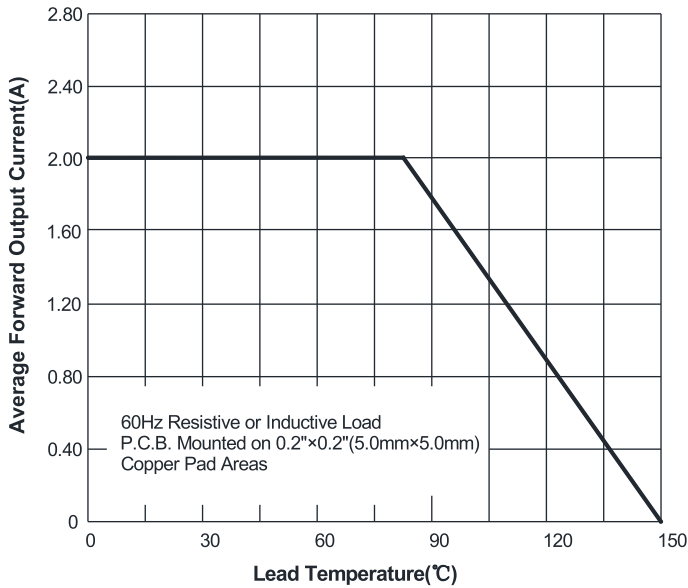

FIG.2: Forward Surge Current Capability

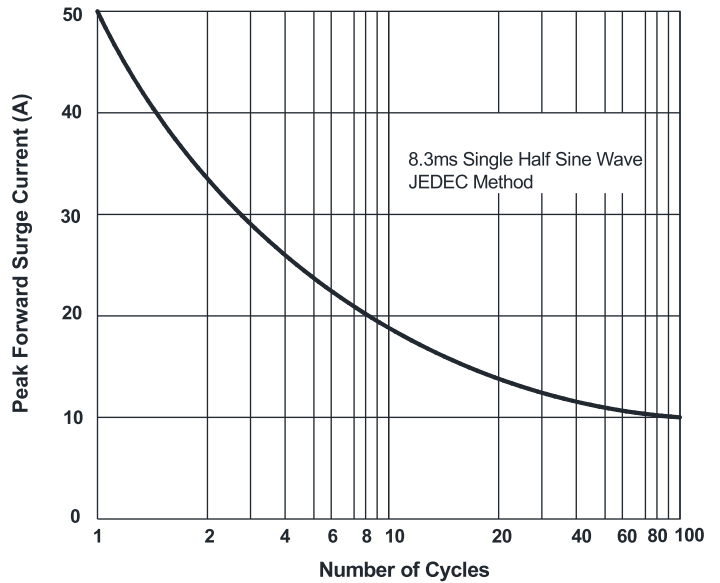

FIG.3: Typical Forward Characteristics

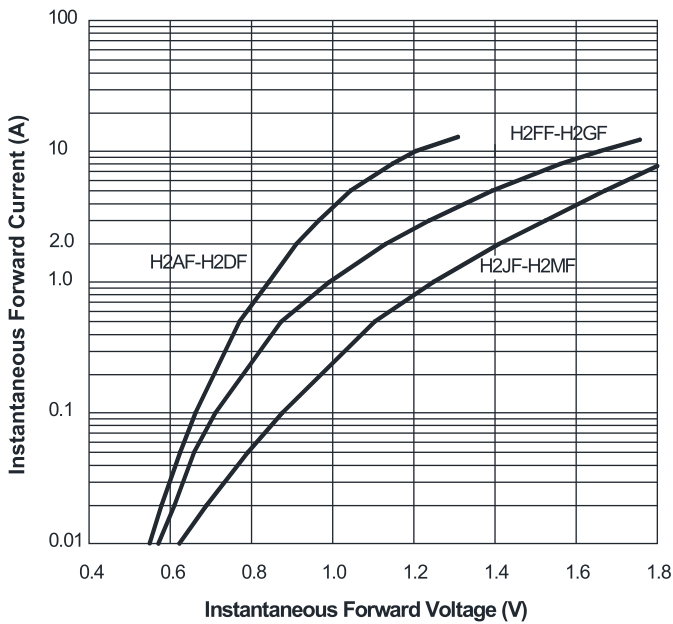

FIG.4: Typical Reverse Characteristics

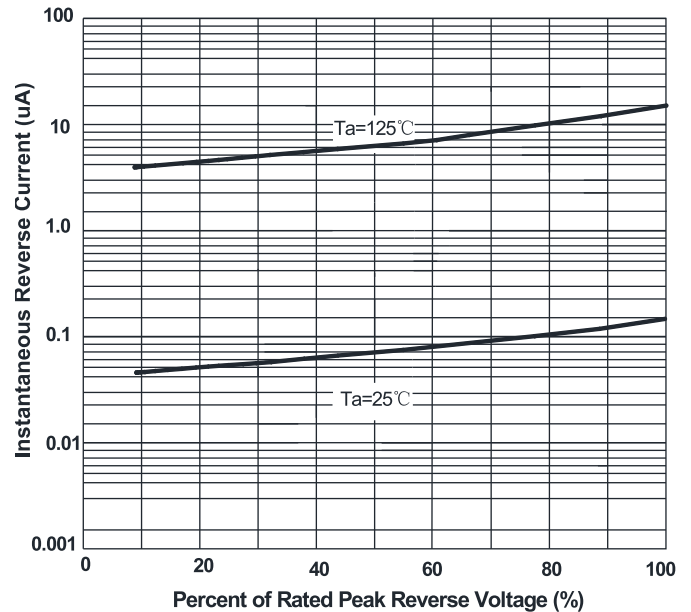
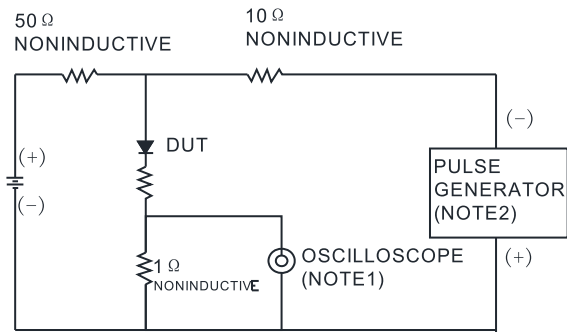
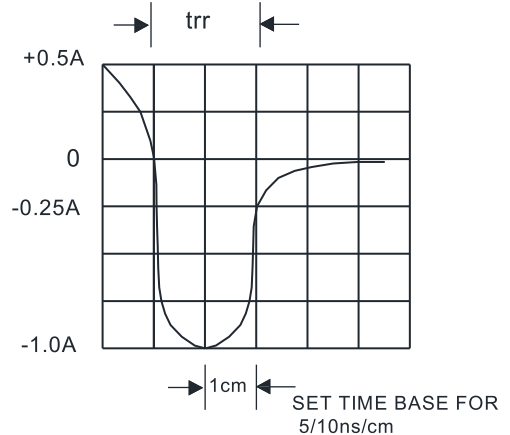

FIG.5: Diagram of circuit and Testing wave form of reverse recovery time



- NOTES:  
 1. Rise Time=7ns max. Input Impedance=1MΩ 22pf  
 2. Rise Time=10ns max. Source Impedance=50Ω



## PACKAGING INFORMATION

PREFERRED P/N	PACKING CODE	UNIT WEIGHT(g)	MINIMUM PACKAGE(pcs)	INNER BOX QUANTITY(pcs)	OUTER CARTON QUANTITY(pcs)	DELIVERY MODE
H2AF-H2MF	X07	Approximate 0.034	3000	12000	96000	7" reel
H2AF-H2MF	Omit for Standard	Approximate 0.034	10000	20000	160000	13" reel

## OUTLINE DIMENSIONS

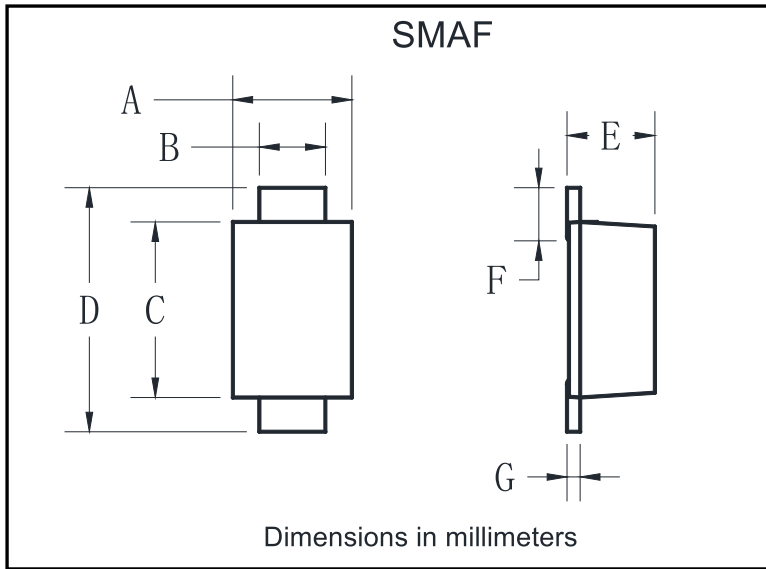

SMAF		
Dim	Min	Max
A	2.40	2.80
B	1.35	1.45
C	3.40	3.60
D	4.40	4.80
E	1.05	1.25
F	0.50	1.00
G	0.15	0.22

## SUGGESTED PAD LAYOUT

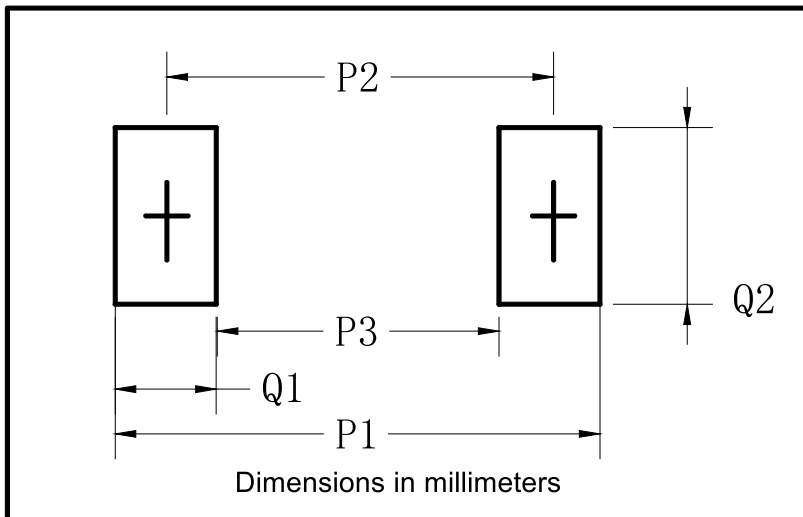

SMAF	
Dim	Millimeters
P1	6.50
P2	4.00
P3	1.50
Q1	2.50
Q2	1.70