

FEATURES

- Low profile package
- Ideal for automated placement
- Glass passivated chip junction
- High forward surge capability
- Super fast reverse recovery time
- Meets MSL level 1, per J-STD-020, LF maximum peak of 260 °C

TYPICAL APPLICATIONS

For use in high frequency rectification of power supplies, inverters, converters, and freewheeling diodes for consumer and telecommunication.

MECHANICAL DATA

- **Package:** DO-214AA (SMB)
Molding compound meets UL 94 V-0 flammability rating, RoHS-compliant, halogen-free
- **Terminals:** Tin plated leads, solderable per J-STD-002 and JESD22-B102
- **Polarity:** Cathode line denotes the cathode end

MAXIMUM RATINGS (T_a=25°C Unless otherwise specified)

PARAMETER	SYMBOL	UNIT	HS3AB	HS3BB	HS3DB	HS3FB	HS3GB	HS3JB	HS3KB	HS3MB
Device marking code			HS3AB	HS3BB	HS3DB	HS3FB	HS3GB	HS3JB	HS3KB	HS3MB
Repetitive peak reverse voltage	VRRM	V	50	100	200	300	400	600	800	1000
Average rectified output current @60Hz sine wave, resistance load, TL (Fig.1)	I _O	A	3.0							
Surge(non-repetitive)forward current @60Hz half-sine wave, 1 cycle, T _a =25°C	I _{FSM}	A	100							
Storage temperature	T _{stg}	°C	-55~+150							
Junction temperature	T _j	°C	-55~+150							

ELECTRICAL CHARACTERISTICS (T_a=25°C Unless otherwise specified)

PARAMETER	SYMBOL	UNIT	TEST CONDITIONS	HS3AB	HS3BB	HS3DB	HS3FB	HS3GB	HS3JB	HS3KB	HS3MB
Maximum instantaneous forward voltage drop per diode	V _F	V	I _{FM} =3.0A	1.0			1.3		1.7		
Maximum reverse recovery time	t _r	ns	I _F =0.5A, I _R =1.0A, I _r =0.25A	50					75		
Maximum DC reverse current at rated DC blocking voltage per diode @ VRM=VRRM	I _{RRM}	μA	T _a =25°C	5							
			T _a =125°C	100							

THERMAL CHARACTERISTICS (T_a=25°C Unless otherwise specified)

PARAMETER	SYMBOL	UNIT	HS3AB	HS3BB	HS3DB	HS3FB	HS3GB	HS3JB	HS3KB	HS3MB
Typical Thermal resistance	R _{θJ-A} (1)	°C/W	70							
	R _{θJ-L} (1)		15							

Note:

(1) Thermal resistance from junction to ambient and from junction to lead mounted on P.C.B. with 0.3" x 0.3" (8.0 mm x 8.0 mm) copper pad areas

CHARACTERISTICS (Typical)

FIG.1: Io-TL Curve

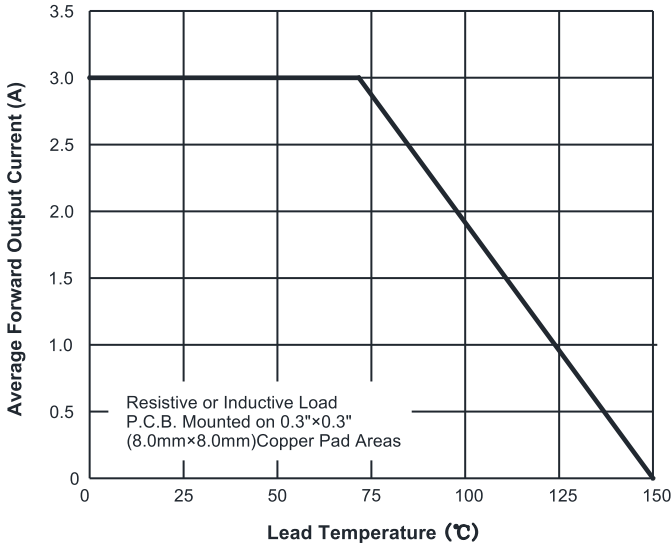

FIG.2: Forward Surge Current Capability

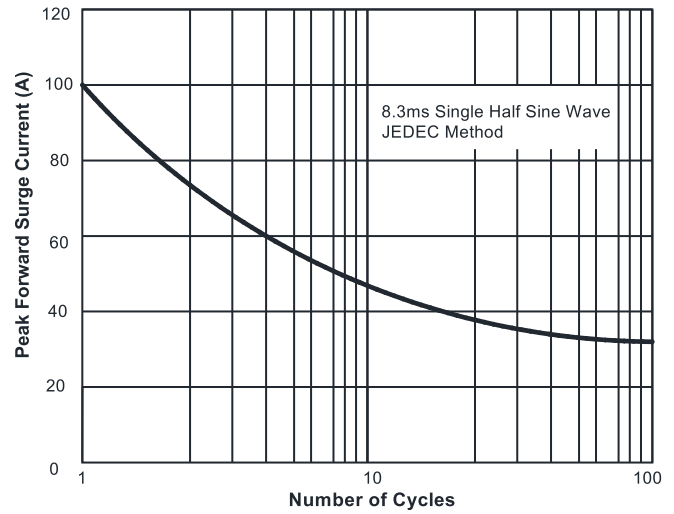

FIG.3: Typical Forward Voltage

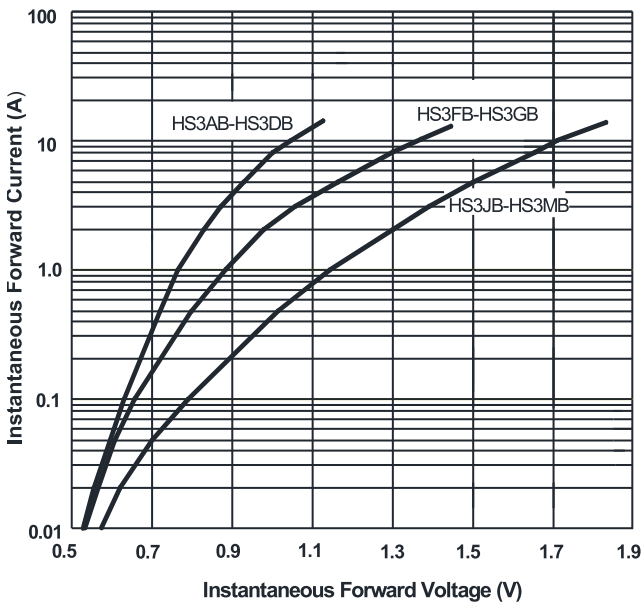

FIG.4: Typical Reverse Characteristics

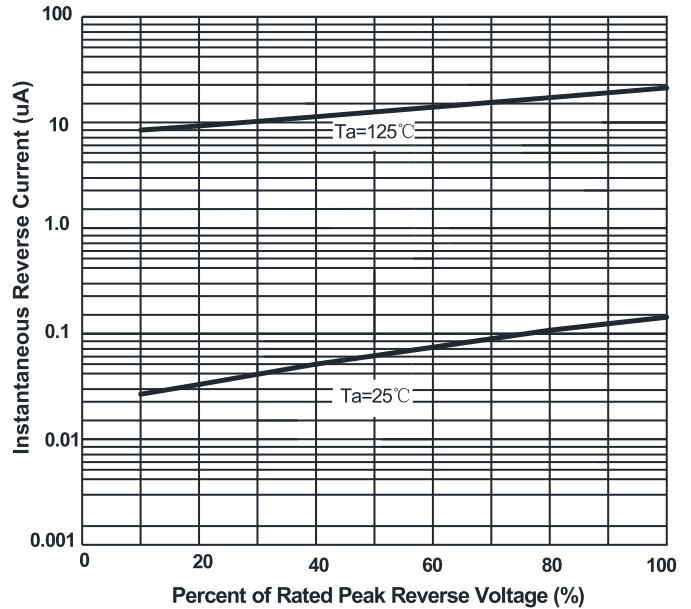
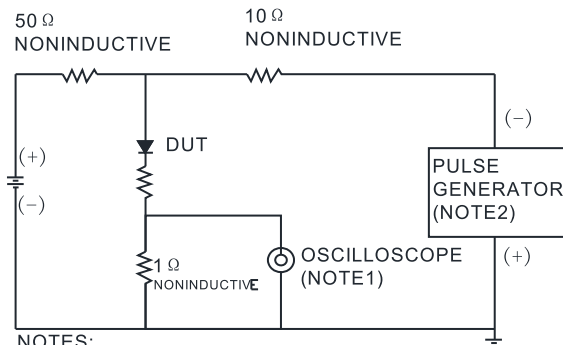
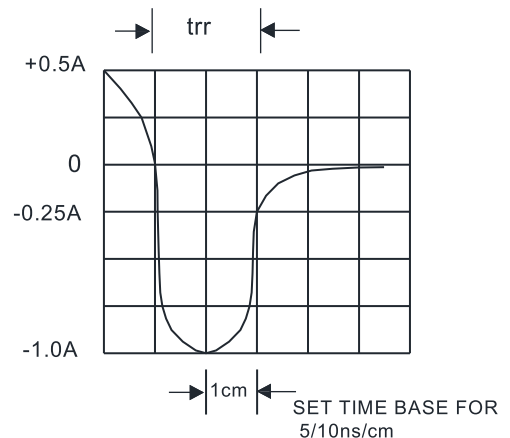

FIG.5: Diagram of circuit and Testing wave form of reverse recovery time



- NOTES:
1. Rise Time=7ns max. Input Impedance=1MΩ 22pf
2. Rise Time=10ns max. Source Impedance=50Ω



PACKAGING INFORMATION

PREFERED P/N	PACKING CODE	UNIT WEIGHT(g)	MINIMUM PACKAGE(pcs)	INNER BOX QUANTITY(pcs)	OUTER CARTON QUANTITY(pcs)	DELIVERY MODE
HS3AB-HS3MB	Omit for Standard	Approximate 0.096	3000	6000	48000	13" reel
HS3AB-HS3MB	X07	Approximate 0.096	750	3000	24000	7" reel

OUTLINE DIMENSIONS

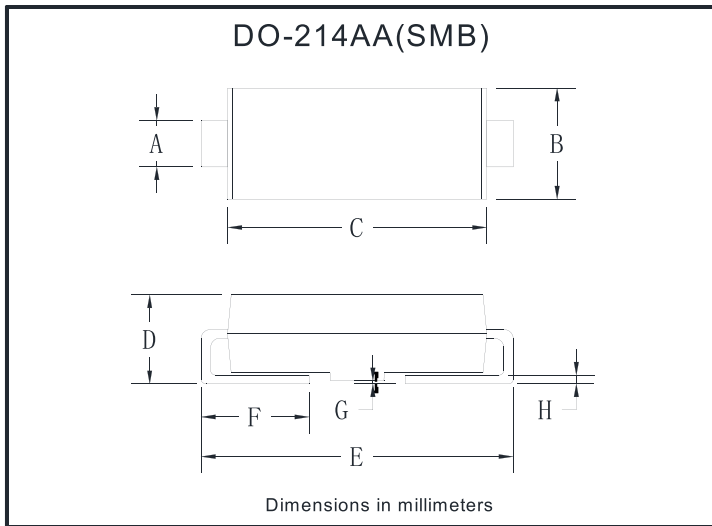

DO-214AA(SMB)		
Dim	Min	Max
A	1.85	2.15
B	3.30	3.94
C	4.25	4.75
D	1.99	2.61
E	5.21	5.59
F	0.90	1.41
G	0.10	0.20
H	0.15	0.31

SUGGESTED PAD LAYOUT

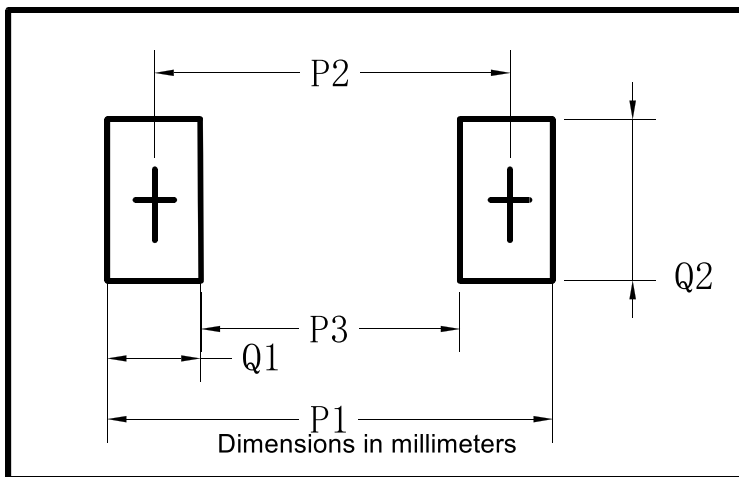

DO-214AA(SMB)	
Dim	Millimeters
P1	6.8
P2	4.3
P3	1.8
Q1	2.5
Q2	2.3