

FEATURES

- Adopt FRED chip
- Low forward Voltage drop
- Fast reverse recovery time
- High frequency operation
- High purity, high temperature epoxy encapsulation for enhanced mechanical strength and moisture resistance
- Guard ring for enhanced ruggedness and long term reliability

TYPICAL APPLICATIONS

Typical applications are in switching power supplies, converters, freewheeling diodes, and reverse battery protection.

MECHANICAL DATA

- **Package:** TO-220AC
Molding compound meets UL 94 V-0 flammability rating, RoHS-compliant
- **Terminals:** Tin plated leads, solderable per J-STD-002 and JESD22-B102
- **Polarity:** As marked

MAXIMUM RATINGS (T_a=25°C Unless otherwise specified)

PARAMETER	SYMBOL	UNIT	MUR540
Device marking code			MUR540
Repetitive Peak Reverse Voltage	V _{RRM}	V	400
Average Rectified Output Current @60Hz sine wave, R-load, (FIG.1)	I _O	A	5
Surge(Non-repetitive)Forward Current @60Hz half sine-wave, 1 cycle, T _a =25°C	I _{FSM}	A	50
Current Squared Time @1ms≤t≤8.3ms T _j =25°C,	I ² t	A ² s	10
Storage Temperature	T _{stg}	°C	-55 ~ +150
Junction Temperature	T _j	°C	-55 ~ +150
Junction capacitance @4V,1MHz	C _j	pF	50

ELECTRICAL CHARACTERISTICS (T_a=25°C Unless otherwise specified)

PARAMETER	SYMBOL	UNIT	TEST CONDITIONS	Min	Typ	Max
Instantaneous forward voltage drop per diode	V _{FM}	V	I _{FM} =5.0A @T _j =25°C	-	1.15	1.25
			I _{FM} =5.0A @T _j =150°C	-	0.9	1
DC reverse current at rated DC blocking voltage per diode	I _{RRM1}	uA	V _{RM} =V _{RRM} T _j =25°C	-	-	5
	I _{RRM2}		V _{RM} =V _{RRM} T _j =150°C	-	25	50
Reverse Recovery Time	T _{RR}	ns	I _F =0.5A I _{RM} =1A I _{RR} =0.25A T _j =25°C	-	25	35
Peak recovery current	I _{RRM}	A	T _j =25°C	-	3.49	-
			T _j =125°C	-	5.71	-
Reverse recovery charge	Q _{rr}	nC	T _j =25°C	-	55.22	-
			T _j =125°C	-	130	-

■ **THERMAL CHARACTERISTICS** ($T_a=25^{\circ}\text{C}$ Unless otherwise specified)

PARAMETER		SYMBOL	UNIT	MUR540
Thermal Resistance	Between junction and case	$R_{\theta J-C}$	$^{\circ}\text{C}/\text{W}$	2.0
	Between junction and Air	$R_{\theta J-A}$	$^{\circ}\text{C}/\text{W}$	50

■ **PACKAGING INFORMATION**

PREFERRED P/N	UNIT WEIGHT(g)	MINIMUM PACKAGE(pcs)	INNER BOX QUANTITY(pcs)	OUTER CARTON QUANTITY(pcs)	DELIVERY MODE
MUR540	Approximate 1.8	50	1000	5000	Tube

■ **CHARACTERISTICS (TYPICAL)**

FIG1: $I_o - T_c$ Curve

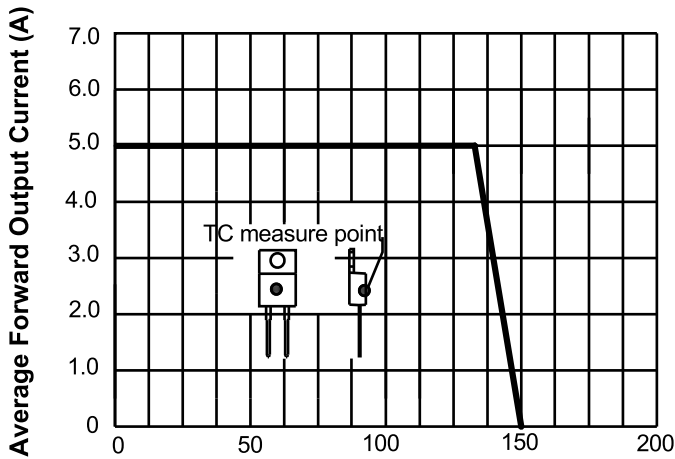

FIG2: Surge Forward Current Capability

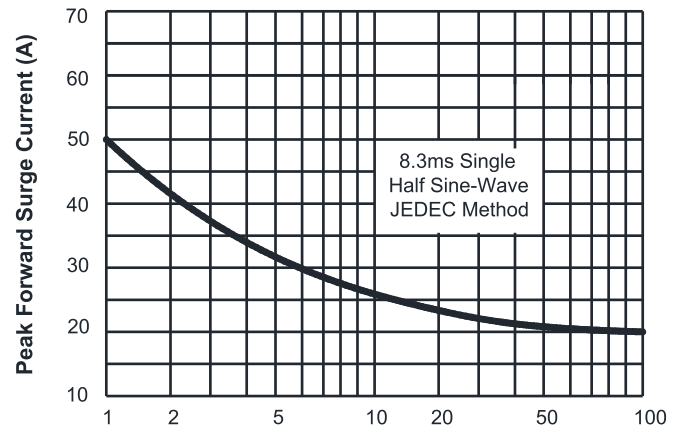

FIG3: Forward Voltage

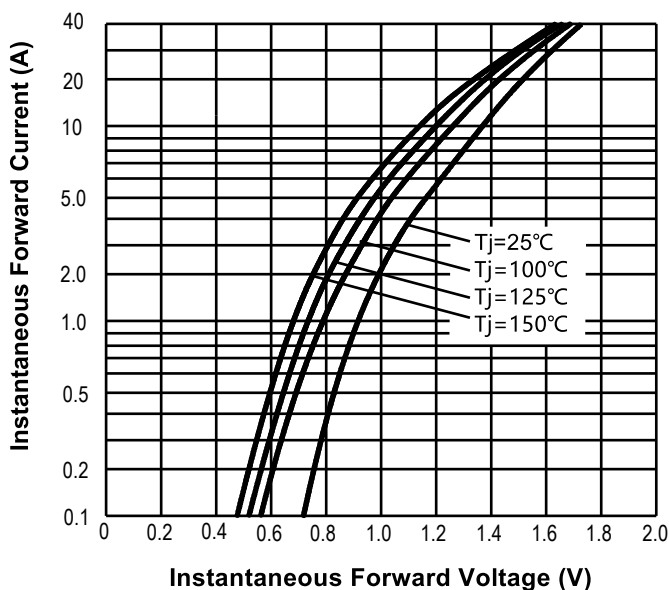

FIG4: Instantaneous Reverse Characteristics

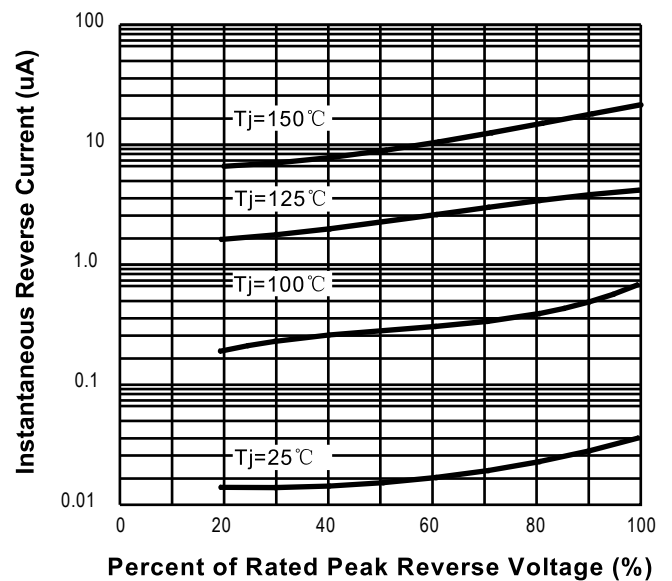
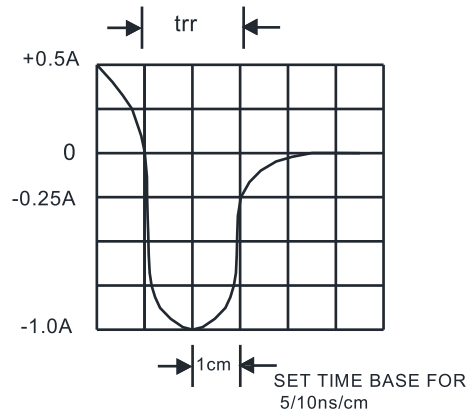
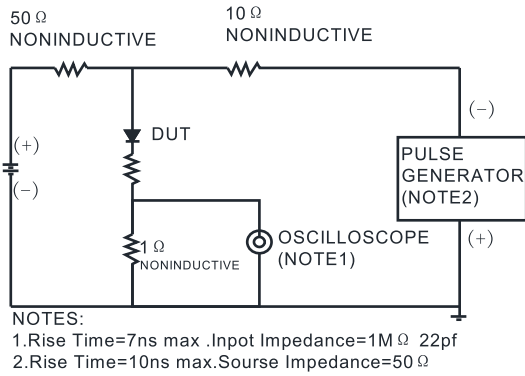
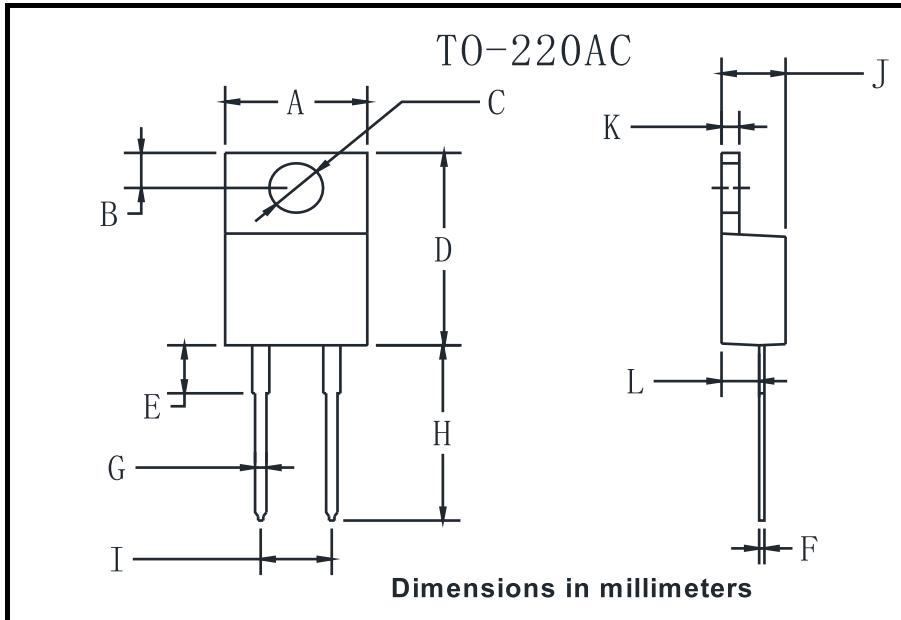

FIG.5: Diagram of circuit and Testing wave form of reverse recovery time



■ **OUTLINE DIMENSIONS**



TO-220AC		
Dim	Min	Max
A	9.95	10.35
B	2.55	2.95
C	3.75	4.05
D	14.95	15.25
E	3.75	4.25
F	0.26	0.5
G	0.68	0.94
H	13.3	13.9
I	4.86	5.26
J	4.38	4.78
K	1.14	1.4
L	2.37	2.79