

FEATURES

- High frequency operation
- High surge forward current capability
- High purity, high temperature epoxy encapsulation for enhanced mechanical strength and moisture resistance
- Guard ring for enhanced ruggedness and long term reliability
- Solder dip 275 °C max. 7 s, per JESD 22-B106

TYPICAL APPLICATIONS

Typical applications are in switching power supplies, converters, freewheeling diodes, and reverse battery protection.

MECHANICAL DATA

- **Package:** TO-220AC
Molding compound meets UL 94 V-0 flammability rating, RoHS-compliant
- **Terminals:** Tin plated leads, solderable per J-STD-002 and JESD22-B102
- **Polarity:** As marked

MAXIMUM RATINGS (T_a=25°C Unless otherwise specified)

PARAMETER	SYMBOL	UNIT	MUR1610	MUR1615	MUR1620
Device Marking Code			MUR1610	MUR1615	MUR1620
Repetitive Peak Reverse Voltage	VRRM	V	100	150	200
Average Rectified Output Current @60Hz half sine-wave, R-load, T _c (FIG.1)	I _o	A	16		
Surge(Non-repetitive)Forward Current @60Hz half sine-wave, 1 cycle, T _a =25°C	I _{FSM}	A	150		
Current Squared Time @1ms≤t<8.3ms T _j =25°C	I ² t	A ² s	94		
Storage Temperature	T _{stg}	°C	-55 ~ +150		
Junction Temperature	T _j	°C	-55 ~ +150		

ELECTRICAL CHARACTERISTICS (T_a=25°C Unless otherwise specified)

PARAMETER	SYMBOL	UNIT	TEST CONDITIONS	MUR1610	MUR1615	MUR1620
Maximum instantaneous forward voltage drop per diode	V _{FM}	V	I _{FM} =16.0A	0.975		
Maximum DC reverse current at rated DC blocking voltage per diode	I _{RRM1}	uA	V _{RM} =V _{RRM} T _a =25°C	10		
	I _{RRM2}		V _{RM} =V _{RRM} T _a =125°C	500		
Reverse Recovery Time	T _{rr}	ns	I _F =0.5A I _{RM} =1A I _{RR} =0.25A	50		

THERMAL CHARACTERISTICS (T_a=25°C Unless otherwise specified)

PARAMETER	SYMBOL	UNIT	MUR1610	MUR1615	MUR1620
Thermal Resistance Between junction and case	R _{θJC}	°C/W	2.0		

PACKAGING INFORMATION

PREFERRED P/N	UNIT WEIGHT(g)	MINIMUM PACKAGE(pcs)	INNER BOX QUANTITY(pcs)	OUTER CARTON QUANTITY(pcs)	DELIVERY MODE
MUR1610 MUR1615 MUR1620	Approximate 1.87	50	1000	5000	Tube

CHARACTERISTICS (TYPICAL)

FIG1: I_o - T_c Curve

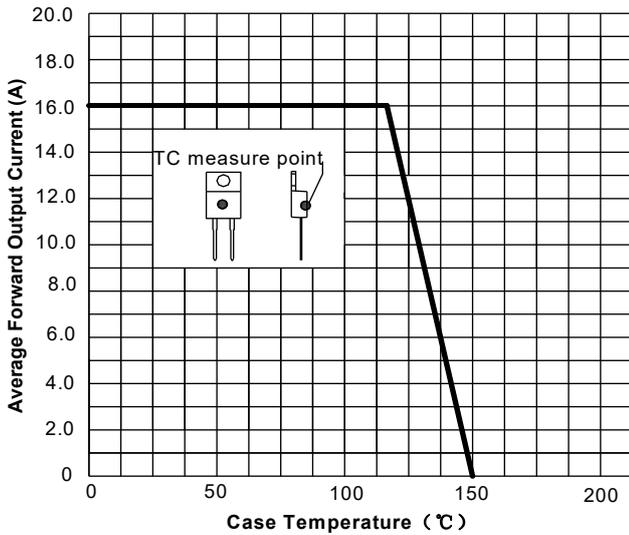

FIG2: Surge Forward Current Capability

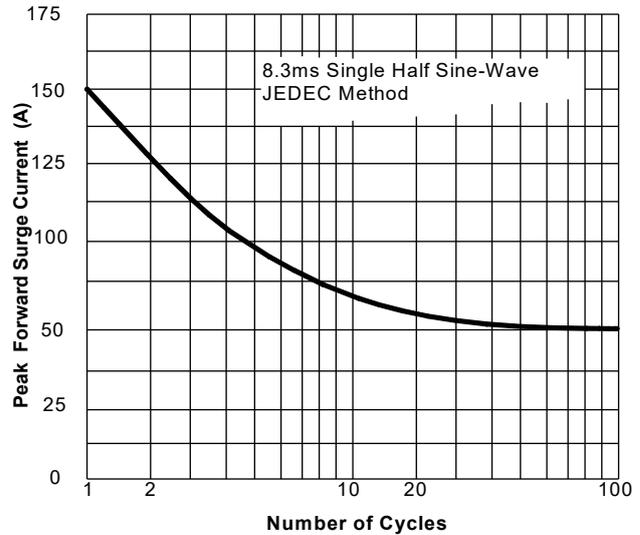

FIG3: Forward Voltage

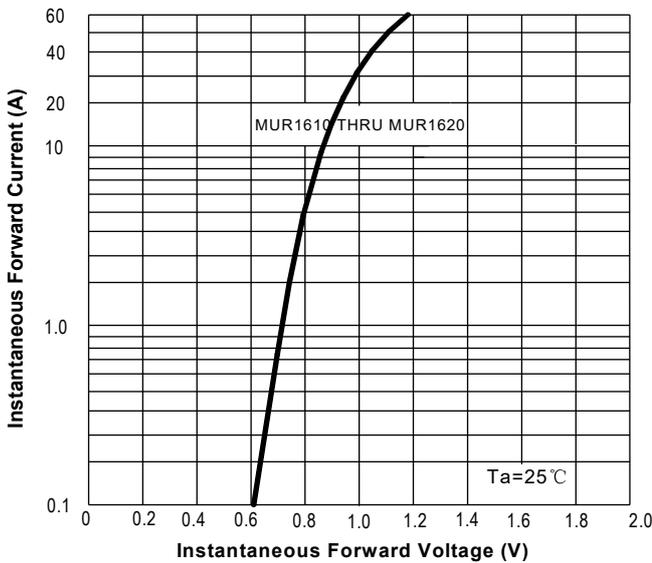

FIG4: Typical Reverse Characteristics

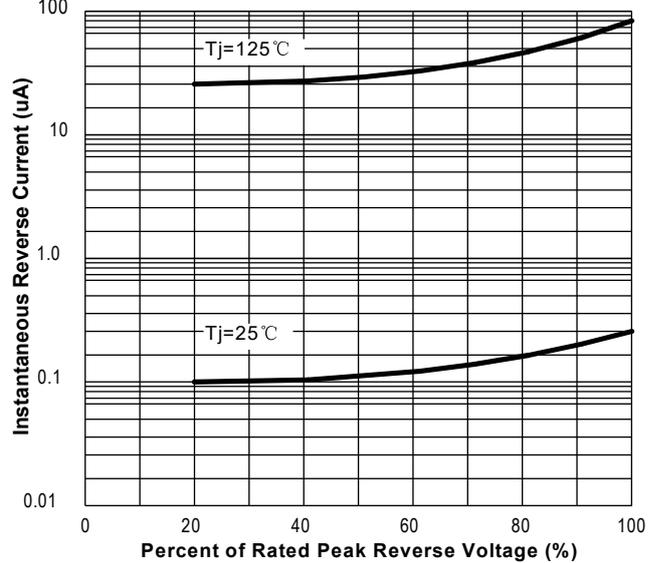
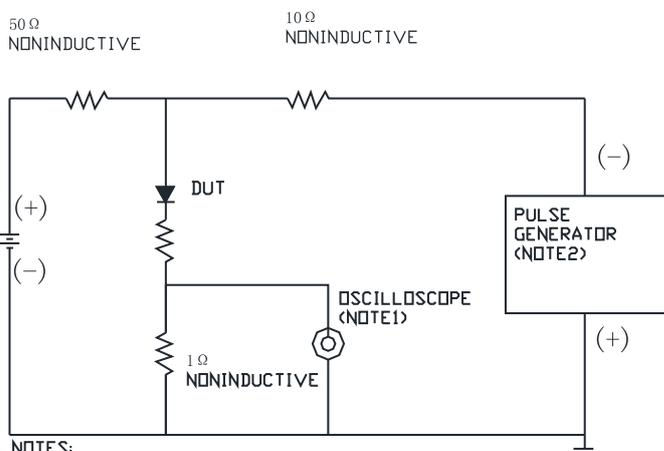
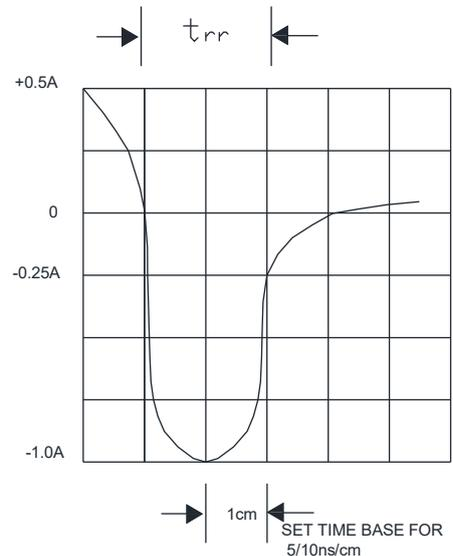

FIG.5 Diagram of circuit and Testing wave form of reverse recovery time



NOTES:
1. Rise Time = 7ns max. Input Impedance = 1MΩ 22pf
2. Rise Time = 10ns max. Source Impedance = 50Ω



■ **OUTLINE DIMENSIONS**

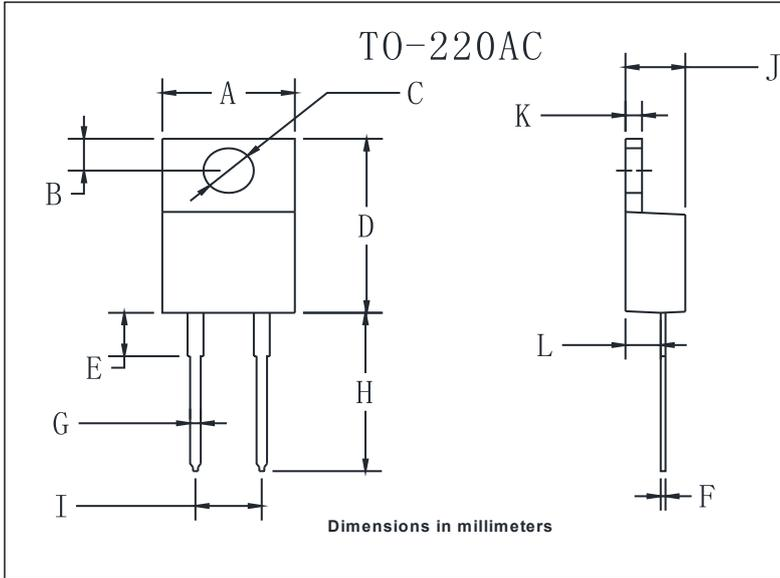

TO-220AC		
Dim	Min	Max
A	9.5	10.9
B	2.22	3.27
C	3.34	4.31
D	14.5	15.5
E	3.16	4.46
F	0.28	0.64
G	0.68	0.94
H	13.06	14.62
I	4.55	5.60
J	4.04	5.1
K	1.14	1.4
L	2.14	3.19