

**Uni-directional**

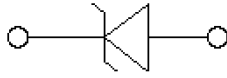

**Bi-directional**

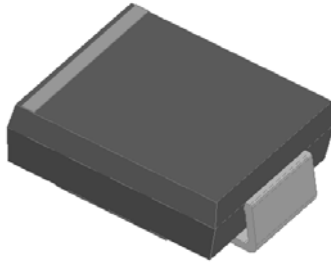
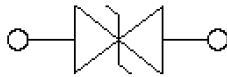
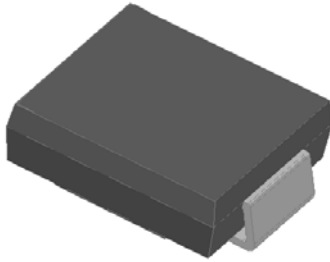

**FEATURES**

- UL recognition, file # E517074
- 5000 W peak pulse power capability with a 10/1000  $\mu$ s waveform
- Low leakage
- Uni and Bidirectional unit
- Excellent clamping capability
- Very fast response time
- Meets MSL level 1

**TYPICAL APPLICATIONS**

Use in sensitive electronics protection against voltage transients induced by inductive load switching and lighting on ICs, MOSFET, signal lines of sensor units for consumer, computer, industrial, telecommunication.

**MECHANICAL DATA**

- **Package:** DO-214AB (SMC)  
Molding compound meets UL 94 V-0 flammability rating, RoHS-compliant
- **Terminals:** Tin plated leads, solderable per J-STD-002 and JESD22-B102
- **Polarity:** For uni-directional types the band denotes cathode end, no marking on bi-directional types

**MAXIMUM RATINGS** ( $T_a=25^\circ\text{C}$  Unless otherwise specified)

PARAMETER	SYMBOL	UNIT	Max
Peak power dissipation, with a 10/1000 $\mu$ s waveform <sup>(1)</sup> <sup>(2)</sup>	$P_{PPM}$	W	5000
Peak pulse current, with a 10/1000 $\mu$ s waveform <sup>(1)</sup>	$I_{PPM}$	A	See Next Table
Power dissipation, on infinite heat sink at $T_L=75^\circ\text{C}$ <sup>(2)</sup>	$P_D$	W	6.5
Peak forward surge current, 8.3 ms single half sine-wave unidirectional only <sup>(3)</sup>	$I_{FSM}$	A	300
Operating junction and storage temperature range	$T_J, T_{STG}$	$^\circ\text{C}$	-55 to +150

**THERMAL CHARACTERISTICS** ( $T_a=25^\circ\text{C}$  Unless otherwise specified)

PARAMETER	SYMBOL	UNIT	Conditions	VALUE
Thermal Resistance(Typical)	$R_{\theta JA}^{(5)}$	$^\circ\text{C/W}$	junction to ambient	75
	$R_{\theta JL}^{(5)}$	$^\circ\text{C/W}$	junction to lead	15
	$R_{\theta JC}^{(5)}$	$^\circ\text{C/W}$	junction to case	13

Notes:

- (1) Non-repetitive current pulse, per Fig. 3 and derated above  $T_A = 25^\circ\text{C}$  per Fig.2.
- (2) Mounted on 0.31 x 0.31" (8.0 x 8.0 mm) copper pads to each terminal
- (3) Measured on 8.3ms single half sine-wave or equivalent square wave,duty cycle=4 pulses per minute maximum.
- (4)  $V_F=3.5\text{V}$  Max for devices of  $V_{BR}\leq 85\text{V}$ , and  $V_F=5.0\text{V}$  Max for devices of  $V_{BR}>85\text{V}$ .
- (5) Mounted on minimum recommended pad layout.

■ **ELECTRICAL CHARACTERISTICS** ( $T_a=25^\circ\text{C}$  Unless otherwise specified)

PARAMETER	SYMBOL	UNIT	VALUE
Maximum instantaneous forward voltage at 100A for unidirectional only <sup>(4)</sup>	$V_{FM}$	V	3.5/5.0

Part Number (Uni)	Part Number (Bi)	Breakdown Voltage $V_{BR}@I_T$			Maximum Reverse Leakage $I_R$ @ $V_{RWM}$ ( $\mu\text{A}$ )	Working Peak Reverse Voltage $V_{RWM}$ (V)	Maximum Reverse Surge Current $I_{PP}^{(2)}$ (A)	Maximum Clamping Voltage $V_C$ @ $I_{PP}$ (V)
		Min(V)	Max (V)	$I_T^{(1)}$ (mA)				
5.0SMDJ11A	5.0SMDJ11CA	12.2	13.5	1.0	800.0	11.0	274.7	18.2
5.0SMDJ12A	5.0SMDJ12CA	13.3	14.7	1.0	800.0	12.0	251.3	19.9
5.0SMDJ13A	5.0SMDJ13CA	14.4	15.9	1.0	500.0	13.0	232.6	21.5
5.0SMDJ14A	5.0SMDJ14CA	15.6	17.2	1.0	200.0	14.0	215.5	23.2
5.0SMDJ15A	5.0SMDJ15CA	16.7	18.5	1.0	100.0	15.0	204.9	24.4
5.0SMDJ16A	5.0SMDJ16CA	17.8	19.7	1.0	50.0	16.0	192.3	26
5.0SMDJ17A	5.0SMDJ17CA	18.9	20.9	1.0	20.0	17.0	181.2	27.6
5.0SMDJ18A	5.0SMDJ18CA	20.0	22.1	1.0	10.0	18.0	171.2	29.2
5.0SMDJ19A	5.0SMDJ19CA	21.1	23.3	1.0	10.0	19.0	162.3	30.8
5.0SMDJ20A	5.0SMDJ20CA	22.2	24.5	1.0	5.0	20.0	154.3	32.4
5.0SMDJ22A	5.0SMDJ22CA	24.4	26.9	1.0	5.0	22.0	140.8	35.5
5.0SMDJ24A	5.0SMDJ24CA	26.7	29.5	1.0	5.0	24.0	128.5	38.9
5.0SMDJ26A	5.0SMDJ26CA	28.9	31.9	1.0	5.0	26.0	118.8	42.1
5.0SMDJ28A	5.0SMDJ28CA	31.1	34.4	1.0	5.0	28.0	110.1	45.4
5.0SMDJ30A	5.0SMDJ30CA	33.3	36.8	1.0	5.0	30.0	103.3	48.4
5.0SMDJ33A	5.0SMDJ33CA	36.7	40.6	1.0	5.0	33.0	93.8	53.3
5.0SMDJ36A	5.0SMDJ36CA	40.0	44.2	1.0	5.0	36.0	86.1	58.1
5.0SMDJ40A	5.0SMDJ40CA	44.4	49.1	1.0	5.0	40.0	77.5	64.5
5.0SMDJ43A	5.0SMDJ43CA	47.8	52.8	1.0	5.0	43.0	72.0	69.4
5.0SMDJ45A	5.0SMDJ45CA	50.0	55.3	1.0	5.0	45.0	68.8	72.7
5.0SMDJ48A	5.0SMDJ48CA	53.3	58.9	1.0	5.0	48.0	64.6	77.4
5.0SMDJ51A	5.0SMDJ51CA	56.7	62.7	1.0	5.0	51.0	60.7	82.4
5.0SMDJ54A	5.0SMDJ54CA	60.0	66.3	1.0	5.0	54.0	57.4	87.1
5.0SMDJ58A	5.0SMDJ58CA	64.4	71.2	1.0	5.0	58.0	53.4	93.6
5.0SMDJ60A	5.0SMDJ60CA	66.7	73.7	1.0	5.0	60.0	51.7	96.8
5.0SMDJ64A	5.0SMDJ64CA	71.1	78.6	1.0	5.0	64.0	48.5	103
5.0SMDJ70A	5.0SMDJ70CA	77.8	86.0	1.0	5.0	70.0	44.2	113
5.0SMDJ75A	5.0SMDJ75CA	83.3	92.1	1.0	5.0	75.0	41.3	121
5.0SMDJ78A	5.0SMDJ78CA	86.7	95.8	1.0	5.0	78.0	39.7	126
5.0SMDJ80A	5.0SMDJ80CA	88.96	97.6	1.0	5.0	80.0	38.6	129.6

■ **ELECTRICAL CHARACTERISTICS** ( $T_a=25^\circ\text{C}$  Unless otherwise specified)

Part Number (Uni)	Part Number (Bi)	Breakdown Voltage $V_{BR}@I_T$			Maximum Reverse Leakage $I_R$ @ $V_{RWM}$ ( $\mu\text{A}$ )	Working Peak Reverse Voltage $V_{RWM}$ (V)	Maximum Reverse Surge Current $I_{PP}^{(2)}$ (A)	Maximum Clamping Voltage $V_c$ @ $I_{PP}$ (V)
		Min(V)	Max (V)	$I_T^{(1)}$ (mA)				
5.0SMDJ85A	5.0SMDJ85CA	94.4	104.0	1.0	5.0	85.0	36.5	137
5.0SMDJ90A	5.0SMDJ90CA	100.0	111.0	1.0	5.0	90.0	34.2	146
5.0SMDJ100A	5.0SMDJ100CA	111.0	123.0	1.0	5.0	100.0	30.9	162
5.0SMDJ110A	5.0SMDJ110CA	122.0	135.0	1.0	5.0	110.0	28.2	177
5.0SMDJ120A	5.0SMDJ120CA	133.0	147.0	1.0	5.0	120.0	25.9	193
5.0SMDJ130A	5.0SMDJ130CA	144.0	159.0	1.0	5.0	130.0	23.9	209
5.0SMDJ140A	5.0SMDJ140CA	155.0	171.0	1.0	5.0	140.0	22.0	226.8
5.0SMDJ150A	5.0SMDJ150CA	167.0	185.0	1.0	5.0	150.0	20.6	243
5.0SMDJ160A	5.0SMDJ160CA	178.0	197.0	1.0	5.0	160.0	19.3	259
5.0SMDJ170A	5.0SMDJ170CA	189.0	209.0	1.0	5.0	170.0	18.2	275
5.0SMDJ180A	5.0SMDJ180CA	200.2	220.0	1.0	5.0	180.0	17.1	291.6
5.0SMDJ190A	5.0SMDJ190CA	211.0	232.0	1.0	5.0	190.0	16.2	307.8
5.0SMDJ200A	5.0SMDJ200CA	224.0	247.0	1.0	5.0	200.0	15.4	324
5.0SMDJ220A	5.0SMDJ220CA	246.0	272.0	1.0	5.0	220.0	14.0	356
5.0SMDJ250A	5.0SMDJ250CA	279.0	309.0	1.0	5.0	250.0	12.3	405
5.0SMDJ300A	5.0SMDJ300CA	335.0	371.0	1.0	5.0	300.0	10.3	486
5.0SMDJ350A	5.0SMDJ350CA	391.0	432.0	1.0	5.0	350.0	8.8	567
5.0SMDJ400A	5.0SMDJ400CA	447.0	494.0	1.0	5.0	400.0	7.7	648
5.0SMDJ440A	5.0SMDJ440CA	492.0	543.0	1.0	5.0	440.0	7.0	713

Notes: (1) Pulse Test:  $t_p \leq 50\text{ms}$  Pulse test:  $t_p \leq 50\text{ms}$ .  
(2) Surge current waveform per Fig. 3 and derated per Fig.2.

■ **PACKAGING INFORMATION**

PREFERRED P/N	PACKAGE CODE	UNIT WEIGHT(g)	MINIMUM PACKAGE(pcs)	INNER BOX QUANTITY(pcs)	OUTER CARTON QUANTITY(pcs)	DELIVERY MODE
5.0SMDJ SERIES	F1	Approximate 0.270	3000	6000	42000	13" reel

■ **CHARACTERISTICS (TYPICAL)**

FIG1: Peak Pulse Power Rating Curve

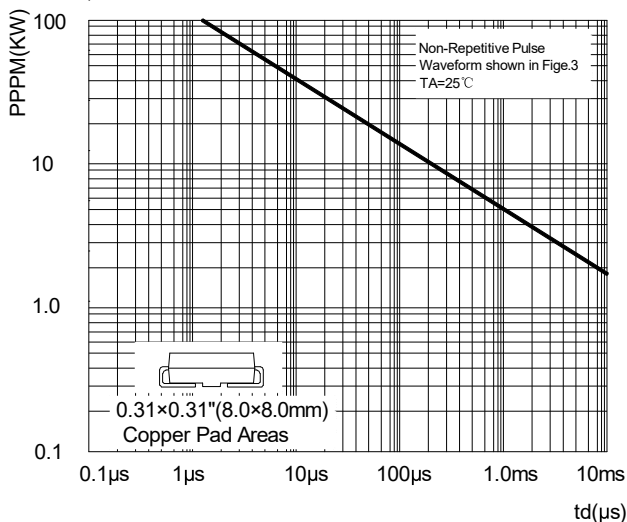
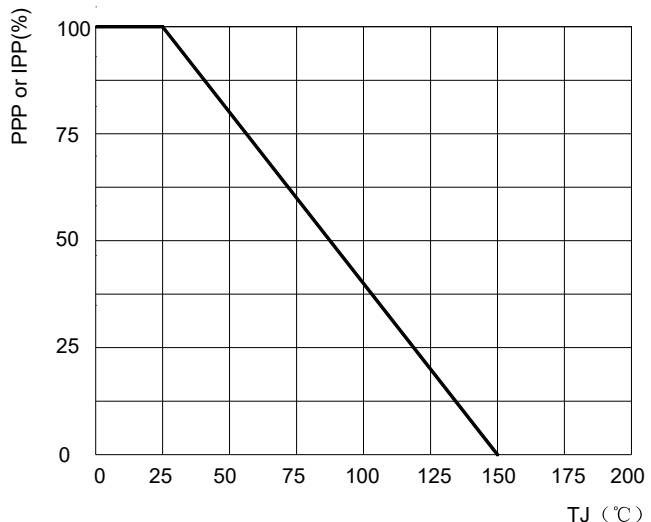

FIG2: Pulse Power or Current vs. Initial Junction Temperature



**CHARACTERISTICS (TYPICAL)**

FIG3: Pulse Waveform

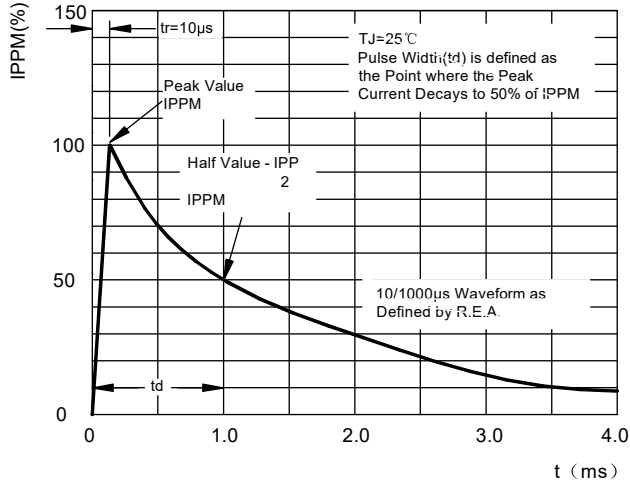

FIG4: Typical Transient Thermal Impedance

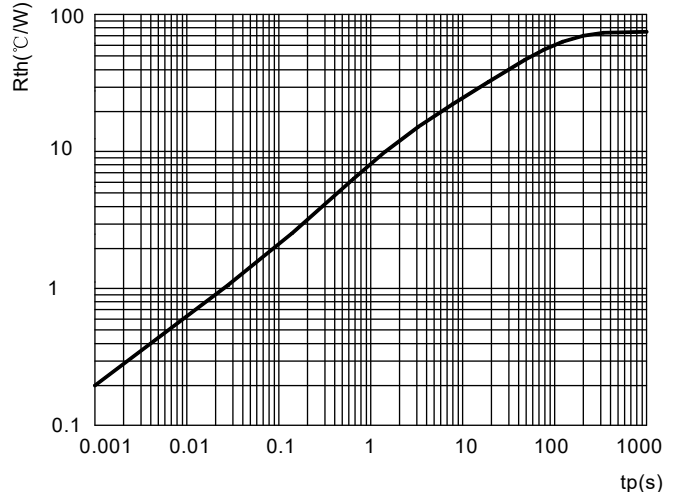

FIG5: Maximum Non-Repetitive Surge Current

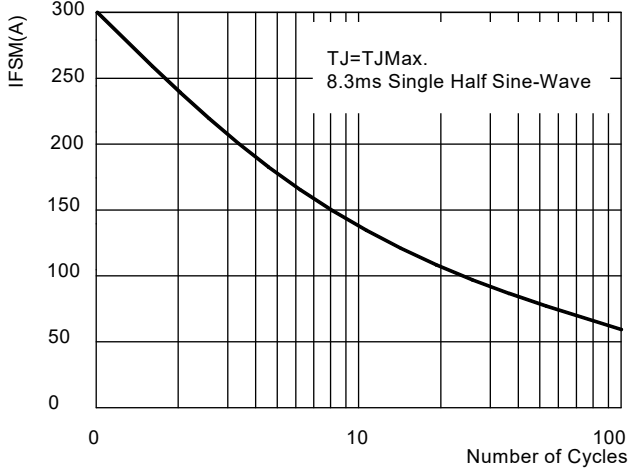
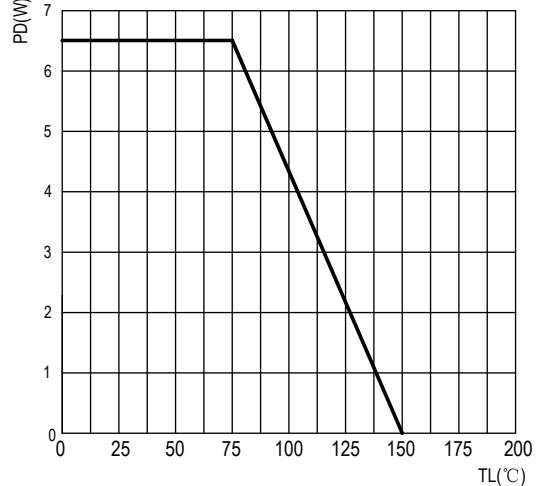
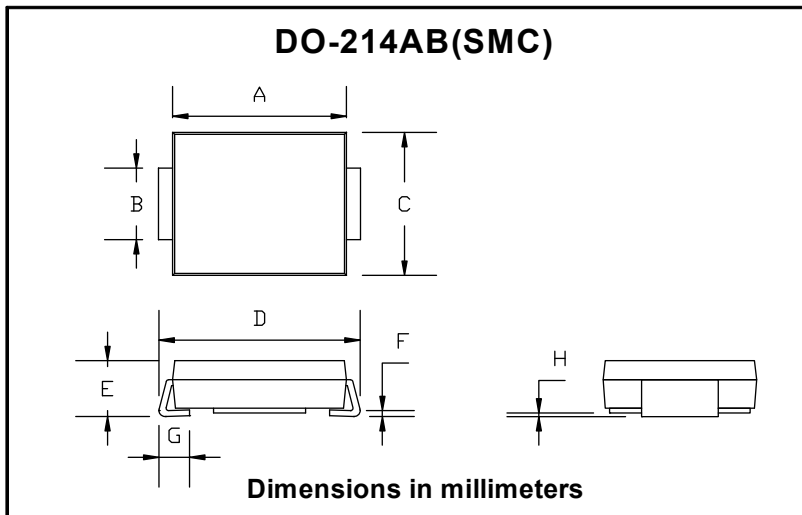

FIG6: Steady State Power Dissipation



**OUTLINE DIMENSIONS**



DO-214AB (SMC)		
Dim	Min	Max
A	6.60	7.11
B	2.85	3.27
C	5.59	6.22
D	7.75	8.13
E	1.99	2.61
F	0.15	0.31
G	0.76	1.52
H	0.05	0.20

■ **SUGGESTED PAD LAYOUT**

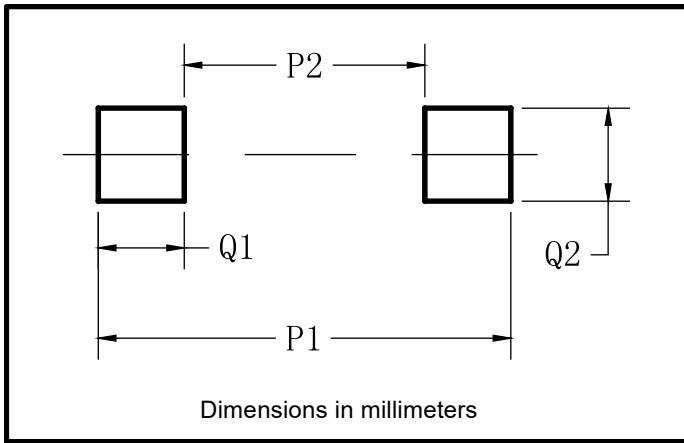

Dim	Min
P1	9.9
P2	3.84
Q1	3.03
Q2	3.82