

CONSTRUCTION

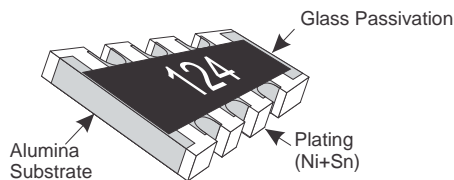

*These resistors are lead free

PART NUMBER EXAMPLE

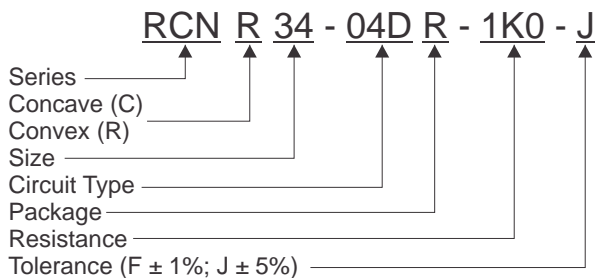

CIRCUITS

02D CIRCUIT

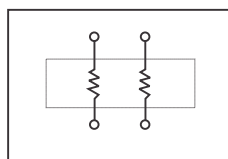

04D CIRCUIT

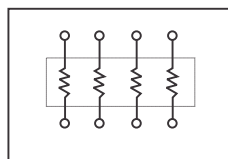

RESISTANCE CODE

Ohms	0.0	1.0	100	1.5K	15K	1.0 Meg
Code	0R0	1R0	100R	1K5	15K	1M0

DIMENSIONS

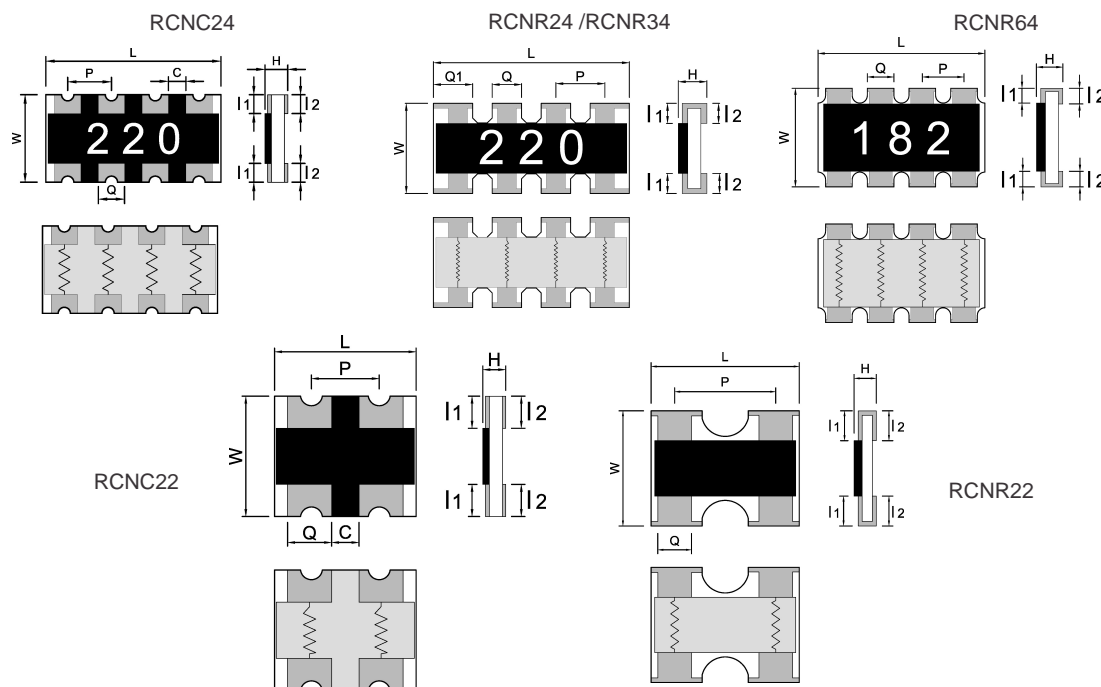

Series	Dimension								
	L	W	H	J	K	P	Q	Q1	Style
RCNR 22	1.0 ± 0.1	1.0 ± 0.1	0.33 ± 0.05	0.15 ± 0.1	0.25 ± 0.1	0.67 ± 0.1	0.34 ± 0.1	N/A	Array
RCNC 22	1.0 ± 0.1	1.0 ± 0.1	0.3 ± 0.1	0.25 ± 0.15	0.25 ± 0.15	0.50 ± 0.1	0.35 ± 0.1	N/A	Array
RCNR 24	2.0 ± 0.1	1.0 ± 0.1	0.4 ± 0.1	0.2 ± 0.1	0.2 ± 0.1	0.5 ± 0.1	0.3 ± 0.1	0.43 ± 0.1	Array
RCNC 24	2.0 ± 0.1	1.0 ± 0.1	0.4 ± 0.1	0.2 ± 0.1	0.2 ± 0.1	0.5 ± 0.1	0.3 ± 0.1	N/A	Array
RCNR 34	3.2 ± 0.2	1.6 ± 0.15	0.5 ± 0.1	0.3 ± 0.2	0.3 ± 0.2	0.8 ± 0.2	0.5 ± 0.1	0.61 ± 0.1	Array
RCNC 34	3.2 ± 0.2	1.6 ± 0.2	0.5 ± 0.1	0.4 ± 0.2	0.4 ± 0.2	0.8 ± 0.1	0.4 ± 0.1	N/A	Array
RCNR 64	5.1 ± 0.2	3.1 ± 0.2	0.55 ± 0.15	0.55 ± 0.15	0.55 ± 0.15	1.3 ± 0.2	0.9 ± 0.1	N/A	Array

ELECTRICAL CHARACTERISTICS & RESISTANCE RANGE

Series	Power Rating Per Element	Max Working Voltage (V)	Max Overload Voltage (V)	Zero Ohm Jumper Rated Current	Resistance Tolerance	Resistance Range ()	Temperature Coefficient PPM / °C	Standard Circuit Types
RCNR 22	0.063W	25	50	1 amp	F (±1%), J (±5%)	1 ~ 9.9 10 ~ 1M	0 ~ +400 ±200	02D
RCNC 22	0.063W	25	50	1 amp	F (±1%), J (±5%)	1 ~ 9.9 10 ~ 1M	0 ~ +400 ±200	02D
RCNR 24	0.063W	25	50	1 amp	F (±1%), J (±5%)	1 ~ 9.9 10 ~ 1M	0 ~ +400 ±200	04D
RCNC 24	0.063W	25	50	1 amp	F (±1%), J (±5%)	1 ~ 9.9 10 ~ 1M	0 ~ +400 ±200	04D
RCNR 34	0.1W	50	100	1 amp	F (±1%), J (±5%)	1 ~ 9.9 10 ~ 1M	0 ~ +400 ±200	04D
RCNR 64	0.25W	200	400	2 amps	F (±1%), J (±5%)	1 ~ 9.9 10 ~ 1M	0 ~ +400 ±200	04D

PERFORMANCE CHARACTERISTICS

Power Derating Curve

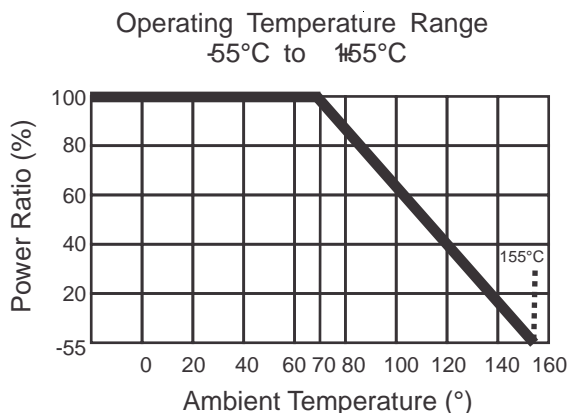

Power rating or current rating is in the case based on continuous full-load at ambient temperature of 70°C. For operation at ambient temperature in excess of 70°C, the load should be derated in accordance with figure of derating Curve.

Voltage Rating or Current Rating

Resistance Range: ≥1

Rated Voltage: The resistor shall have a DC continuous working voltage or a RMS AC continuous working voltage at commercial-line frequency and wave form corresponding to the power rating, as determined formula as follows:

$$E = \sqrt{P \times R}$$

E = Rated Voltage (V)
 P = Power Rating (W)
 R = Nominal Resistance ()

OPERATION AND STORAGE TEMPERATURES

	MIN	MAX
Operation temperature (at full power)	-55°C	70°C
Storage temperature	20°C	30°C
Storage humidity	30°C	70°C

TEST PROCEDURES AND REQUIREMENTS

Test Item	Test Method	Procedure	Requirements
Temperature Coefficient of Resistance (T.C.R)	JIS C 5201-1 clause 4.8	-55°C ~ +155°C, 20°C is the reference temperature	Refer to Ratings
Short Time Overload	JIS C 5201-1 clause 4.13	General: 2.5 times RCWV or Max. Overload voltage for 5 sec. High Power: 2.5 times RCWV or Max. Overload voltage for 2 sec.	±1 : ±(1.0%+0.05) ±5 : ±(1.0%+0.05)
IR Reflow	Sony SS-00254		±1 : ±(1.0%+0.05) ±5 : ±(1.0%+0.05)
Leaching	Sony SS-00254-9	260±5°C for 30 seconds	> 95% Coverage
Soldering Heat	JIS C 5201-1 clause 4.18	260±5°C for 10 seconds	±1 : ±(0.5%+0.05) ±5 : ±(1.0%+0.05)
Temperature Cycling	JIS C 5201-1 clause 4.19	-55°C to +155°C, 5 cycles	0.1%, 0.5%, 1%: ±(0.5%+0.05) 2%, 5%: ±(1.0%+0.10)
Electric Iron	Sony SS-00254-5	Preheating temperature: 350 ±5°C Electric iron preheating time: 3+1/-0 sec.	±1 : ±(1.0%+0.05) ±5 : ±(1.0%+0.05)
Resistance to Solvent	JIS C 5201-1 clause 4.29	The tested resistor be immersed into isopropyl alcohol of 20~25°C for 60 secs. Then the resistor is left in the room for 48 hrs.	±1 : ±(0.5%+0.05) ±5 : ±(0.5%+0.05)
Load Life in Humidity	JIS C 5201-1 clause 4.24	40±2°C, 90~95% R.H. or Max. working voltage for 1,000 hrs with 1.5 hrs "ON" and 0.5 hr "OFF".	0.1%, 0.5%, 1%: ±(0.5%+0.05) 2%, 5%: ±(2.0%+0.05)
Load Life (Endurance)	JIS C 5201-1 clause 4.25	70±2°C, or Max. working voltage for 1,000 hrs with 1.5 hrs "ON" and 0.5 hr "OFF".	0.1%, 0.5%, 1%: ±(1.0%+0.05) 2%, 5%: ±(3.0%+0.10)
Insulation Resistance	JIS C 5201-1 clause 4.6	Max. Overload voltage for 1 minute.	= 10G

■ **PACKAGING**

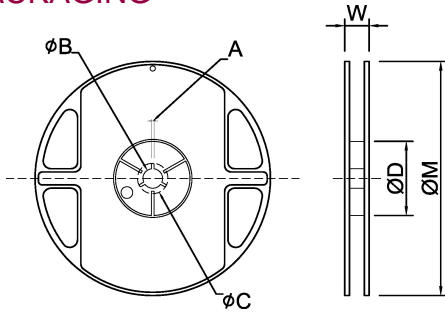

TYPE	SIZE	A	B	C	D	W	M
RCNR22	7" 10K/Reel	2.0±0.5	13.5±1.0	21±1.0	60±1.0	11.5±2.0	178±2.0
RCNC22							
RCNR24							
RCNC24	7" 5K/Reel	2.0±0.5	13.5±1.0	21±1.0	60±1.0	11.5±2.0	178±2.0
RCNR34							
RCNC64							

■ **TAPPING SPECIFICATION**

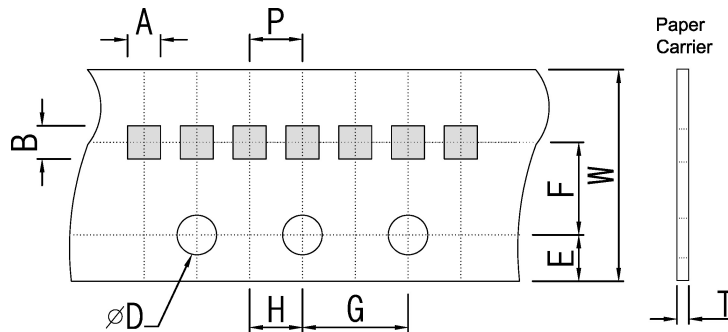

Packaging	Type	A	B	W	E	F	G	H	T	D	P
Paper Type	RCNR22	1.25±0.10	1.25±0.10	8.0±0.20	1.75±0.10	3.5±0.05	4.0±0.10	2.0±0.05	0.45±0.10	1.50±0.10	2.0±0.1
	RCNC22	1.25±0.10	1.25±0.10	8.0±0.20	1.75±0.10	3.5±0.05	4.0±0.10	2.0±0.05	0.45±0.10	1.50±0.10	
	RCNR24	1.20±0.10	2.20±0.10	8.0±0.20	1.75±0.10	3.5±0.05	4.0±0.10	2.0±0.05	0.60±0.10	1.50±0.10	
	RCNC24	1.20±0.10	2.20±0.10	8.0±0.20	1.75±0.10	3.5±0.05	4.0±0.10	2.0±0.05	0.60±0.10	1.50±0.10	
	RCNR34	1.90±0.20	3.45±0.20	8.0±0.20	1.75±0.10	3.5±0.05	4.0±0.10	2.0±0.05	0.75±0.10	1.50±0.10	4.0±0.1