

FEATURES

- 85°C, 2000hrs for Dia ≤ 8mm, 3000hrs Dia ≥ 10mm
- Standard series for general purpose
- Replaces RC, RE & RH Series

SPECIFICATIONS

Item	Performance																
Operating Temp.	-40°C ~ +85°C																
Capacitance Tolerance	± 20% (120Hz, 20°C)																
Leakage Current (at 20°C)	Rated Voltage	≤ 100V								>100V							
	Time	After 2 minutes								After 5 minutes							
	Leakage Current	I = 0.01CV or 3 (μA) whichever is greater								CV ≤ 1000 I = 0.03CV + 15(μA)				CV > 1000 I = 0.02CV + 25(μA)			
	Where C = rated capacitance in μF. V = rated DC working voltage in V.																
Dissipation Factor Tan δ at 120Hz, 20°C	Rated Voltage	6.3	10	16	25	35	50	63	100	160	200	250	350	400	450		
	Tan δ (max)	0.23	0.20	0.16	0.14	0.12	0.10	0.09	0.08	0.12	0.14	0.17	0.20	0.25	0.25		
	When the capacitance exceeds 1000μF, 0.02 shall be added for every 1000μF increase.																
Low Temperature Characteristics (at 120Hz)	Impedance ratio shall not exceed the values given in the table below.																
	Rated Voltage		6.3	10	16	25	35	50	63	100	160	200	250	350	400	550	
	Impedance Ratio	Z(-25°C)	D<16	6	4	3	3	2	2	2	2	3	6	8	12	14	16
		/Z(+20°C)	D≥16	8	6	4	4	3	3	3	3	4	8	10	16	18	20
		Z(-40°C)	D<16	10	8	6	6	4	3	3	3	4	8	10	16	18	20
/Z(+20°C)		D≥16	18	16	12	10	8	8	6	6	4	8	10	16	18	20	
Load Life test at 20°C (after rated voltage is applied at 85°C for 2000 / 3000 hours)	Test Time	2000hrs(3000hrs for D ≥ 10mm)						Shelf Life at 20°C after exposure to 85 for 1000 hours with no voltage				Test Time		1000hrs			
	Capacitance Change	Within ± 20% of initial value										Capacitance Change		Within ± 20% of initial value			
	Dissipation Factor	Less than 200% of specific value										Dissipation Factor		Less than 200% of specific value			
	Leakage Current	Within specified value										Leakage Current		Within specified value			
Ripple Current & Frequency Multipliers	Cap. (μF)	Freq. (Hz)	60 (50)	120	500	1K	10K up										
		Under 100	0.70	1.00	1.30	1.40	1.50										
		100 to 1000	0.75	1.00	1.20	1.30	1.35										
		1000 and above	0.80	1.00	1.10	1.12	1.15										
Ripple Current & Temperature Multipliers	Temperature (°C)	Under 50	70	85													
	Mutipliers	1.78	1.4	1.00													
Standards	Satisfies Characteristic W of JIS C 5141																

DIMENSION & PERMISSIBLE RIPPLE CURRENT

Ripple Current :mA/rms at 120Hz, 85°C

μF	V.DC Code	6.3V (0J)		10V (1A)		16V (1C)		25V (1E)		35V (1V)		50V (1H)		63V (1J)		100V (2A)		
		D x L	mA	D x L	mA	D x L	mA	D x L	mA	D x L	mA	D x L	mA	D x L	mA	D x L	mA	
0.1	0R1											5 x 11	1.5	5 x 11	3	5 x 11	3	
0.2	R22											5 x 11	3.5	5 x 11	5	5 x 11	5.8	
0.3	R33											5 x 11	5	5 x 11	8	5 x 11	8.8	
0.5	R47											5 x 11	7	5 x 11	10	5 x 11	12	
1.0	10											5 x 11	15	5 x 11	17	5 x 11	22	
2.2	2R2											5 x 11	29	5 x 11	28	5 x 11	33	
3.3	3R3											5 x 11	35	5 x 11	34	5 x 11	40	
4.7	4R7							5 x 11	31	5 x 11	40	5 x 11	42	5 x 11	45	5 x 11	48	
10	100					5 x 11	49	5 x 11	54	5 x 11	58	5 x 11	65	5 x 11	70	5 x 11	59	
																6.3 x 11	80	
22	220			5 x 11	70	5 x 11	75	5 x 11	80	5 x 11	87	5 x 11	95	6.3 x 11	115	6.3 x 11	115	
																8 x 11.5	135	
33	330	5 x 11	72	5 x 11	84	5 x 11	90	5 x 11	97	5 x 11	108	5 x 11	136	6.3 x 11	140	8 x 11.5	145	
											6.3 x 11	115	6.3 x 11	163	340	10 x 16	195	
47	470	5 x 11	90	5 x 11	100	5 x 11	110	5 x 11	115	5 x 11	130	5 x 11	165	6.3 x 11	170	10 x 13	235	
											6.3 x 11	145	6.3 x 11	165	8 x 11.5	397	10 x 16	255

DIMENSION & PERMISSIBLE RIPPLE CURRENT

Ripple Current: mA/rms at 120 Hz, 85°C

µF	V.DC Code	6.3V (0J)		10V (1A)		16V (1C)		25V (1E)		35V (1V)		50V (1H)		63V (1J)		100V (2A)		
		D x L	mA	D x L	mA	D x L	mA	D x L	mA	D x L	mA	D x L	mA	D x L	mA	D x L	mA	
100	101	5 x 11	130	5 x 11	145	5 x 11 6.3 x 11	160 180	6.3 x 11	190	6.3 x 11 8 x 11.5	260 260	8 x 11.5	260	8 x 11.5 10 x 12.5	245 485	10 x 16 10 x 20	490 370	
220	221	5 x 11 6.3 x 11	200 230	5 x 11 6.3 x 11	220 250	6.3 x 11 8 x 11.5	260 300	8 x 11.5	320	8 x 11.5 10 x 12.5	385 420	10 x 12.5 10 x 16	455 490	10 x 16 10 x 20	490 565	12.5 x 20 12.5 x 25	640 675	
330	331	6.3 x 11 8 x 11.5	270 290	6.3 x 11 8 x 11.5	290 350	8 x 11.5	370	8 x 11.5 10 x 12.5	440 470	8 x 11.5 10 x 16	490 570	10 x 16 12.5 x 20	585 635	10 x 20 12.5 x 20	710 765	16 x 20 16 x 25	695 825	
470	471	6.3 x 11 8 x 11.5	320 380	8 x 11.5 6.3 x 11	350 415	8 x 11.5 10 x 12.5	440 520	10 x 12.5 10 x 16	545 620	10 x 16 740	740	12.5 x 16* 16 x 16* 10 x 20 12.5 x 20	610 745 765 860	12.5 x 20 16 x 25	900 1050	16 x 31.5 18 x 35.5	1070 1135	
1000	102	8 x 11.5	540	8 x 11.5 10 x 12.5	550 650	10 x 16	785	12.5 x 16* 10 x 20 12.5 x 20	830 955 1090	16 x 16* 12.5 x 20	1010 1145	16 x 20* 12.5 x 25 16 x 25	1160 1340 1530	16 x 25 16 x 31.5	1560 1700	18 x 40 22 x 40	2410 2600	
2200	222	10 x 20	1000	12.5 x 16* 10 x 20 12.5 x 20	970 1070 1240	12.5 x 16* 16 x 16* 12.5 x 20	930 1160 1295	16 x 16* 16 x 20* 12.5 x 25 16 x 25	1150 1360 1540 1660	16 x 20* 18 x 20* 16 x 25 16 x 31.5	1490 1560 1785 1890	16 x 35.5 18 x 40	2075 2231	18 x 31.5 18 x 35.5 18 x 40	1955 2100 2385			
3300	332	10 x 20 12.5 x 20 12.5 x 16*	1185 1380 960	16 x 16* 12.5 x 20	1310 1420	12.5 x 20 12.5 x 25 16 x 20* 16 x 16*	1370 1653 1460 1240	16 x 25 16 x 32 18 x 20* 16 x 20*	1975 2070 1720 1490	18 x 25* 16 x 35.5 18 x 35.5	1970 2275 2430	18 x 35.5 22 x 40	2500 2785	22 x 40 3000				
4700	472	16 x 16* 12.5 x 20 16 x 25	1410 1545 1880	16 x 16* 16 x 20* 12.5 x 25 16 x 25	1420 1560 1780 1980	16 x 20* 18 x 20* 16 x 25 16 x 31.5	1600 1770 2090 2260	16 x 25* 16 x 31.5 18 x 35.5	2070 2420 2520	18 x 35.5 2700	2700	22 x 40 25 x 40	3155 3300	25 x 40 3560				
6800	682	16 x 20* 12.5 x 25 16 x 25	1660 1880 2120	18 x 20* 16 x 20* 16 x 25	1870 1700 2220	18 x 25* 18 x 20* 16 x 31.5	2170 1850 2520	18 x 35.5	2880									
10000	103	18 x 20* 16 x 25 16 x 31.5	2020 2530 2500	16 x 20* 18 x 25* 16 x 35.5	2050 2370 2670 2880	18 x 35.5 18 x 40	2920 3080	18 x 40 22 x 40	3080 3440									
22000	223	22 x 40	3700	18 x 40 22 x 40	3370 3790	22 x 40	2900											

µF	V.DC Code	160V (2G)		200V (2D)		250V (2E)		350V (2V)		400V (2G)		450V (2W)	
		D x L	mA	D x L	mA	D x L	mA	D x L	mA	D x L	mA	D x L	mA
0.47	R47	5 x 11 6.3 x 11	13 15	5 x 11 6.3 x 11	14 16	8 x 11.5	21	6.3 x 11 8 x 12	18 21	8 x 11.5 10 x 12.5	21 26	8 x 11.5 10 x 12.5	21 26
1.0	010	5 x 11 6.3 x 11	20 24	5 x 11 6.3 x 11	21 25	8 x 11.5	32	6.3 x 11.0 8 x 12	27 32	8 x 11.5 10 x 12.5	32 38	8 x 11.5 10 x 12.5	32 38
2.2	2R2	5 x 11 6.3 x 11	29 34	6.3 x 11 8 x 11.5	37 44	6.3 x 11 8 x 11.5	42 49	8 x 11.5 10 x 16.0	49 63	8 x 12.5 10 x 16	57 63	10 x 12.5 10 x 16	57 63
3.3	3R3	6.3 x 11 8 x 11.5	43 50	6.3 x 11 8 x 11.5	46 54	8 x 11.5 10 x 12.5	60 70	10 x 12.5 10 x 16	70 78	10 x 16 10 x 20	78 86	10 x 12.5 10 x 16	78 86
4.7	4R7	6.3 x 11 8 x 11.5	51 60	8 x 11.5 10 x 12.5	64 76	8 x 11.5 10 x 16	72 93	10 x 16 10 x 20	93 103	10 x 12.5 10 x 20	80 103	10 x 12.5 10 x 10.3	75 103
10	100	10 x 12.5 10 x 16	104 115	10 x 12.5 10 x 20	112 138	10 x 16 10 x 20	138 150	10 x 20 12.5 x 20	150 174	12.5 x 16* 10 x 20 12.5 x 20 12.5 x 20	150 140 174 150	10 x 20 12.5 x 20	140 174
22	220	10 x 20 12.5 x 20	189 216	10 x 20 12.5 x 20	204 243	10 x 20 12.5 x 20 12.5 x 16*	220 255 280	12.5 x 20 12.5 x 25	255 282	12.5 x 20 12.5 x 25 16 x 16*	280 318 280	12.5 x 25 16 x 25	300 354
33	330	10 x 20 12.5 x 20 12.5 x 16*	228 270 305	12.5 x 16* 12.5 x 20 16 x 16*	350 210 288 350	12.5 x 20 12.5 x 25 16 x 16*	310 348 350	16 x 25 16 x 31.5	390 438	13 x 25 16 x 25 16 x 20*	325 426 355	16 x 20 16 x 31.5 18 x 35.5	350 378 426
47	470	12.5 x 20 16 x 16* 12.5 x 16* 12.5 x 25	318 354 360 420	12.5 x 20 16 x 16* 16 x 20* 12.5 x 25	300 390 420 378	12.5 x 25 16 x 20* 16 x 25	420 420 468	16 x 20 16 x 31.5	385 474	16 x 25 16 x 31.5 18 x 20*	395 485 435	16 x 31.5 18 x 40	460 414 555
68	680	16 x 16* 16 x 20*	440 490	16 x 16* 18 x 20*	470 190	18 x 20*	490						
100	101	12.5 x 25 16 x 25 16 x 20* 18 x 20*	510 582 560 590	16 x 20* 16 x 25 18 x 25* 16 x 35.5	520 582 590 678	16 x 35.5 16 x 31.5	732 645	16 x 31.5 18 x 40	645 685	18 x 35.5 22 x 40	600 710	18 x 40 22 x 45	630 750
150	151	18 x 20* 18 x 25*	640 710										
220	221	16 x 31.5 18 x 35.5	792 900	18 x 31.5 18 x 35.5	825 1002								
330	331	18 x 35.5 18 x 40	984 1010	18 x 40	1200								

* = Flat (non-vented) rubber bung.
Other units are made with raised (vented) rubber bung.

LEAD SPACING AND DIAMETER

	D	5	6.3	8	10	13	16	18	22	25
P	2.0	2.5	3.5	5.0	5.0	7.5	7.5	10	12.5	
d	0.5		0.6		0.8			1.0		
α		1.0		1.5		2.0				
β				0.5						

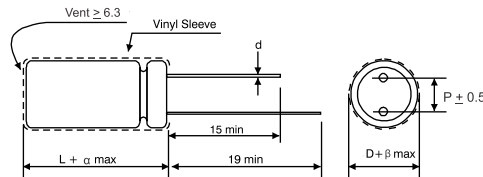

■ **HOW TO MAKE A PART NUMBER**

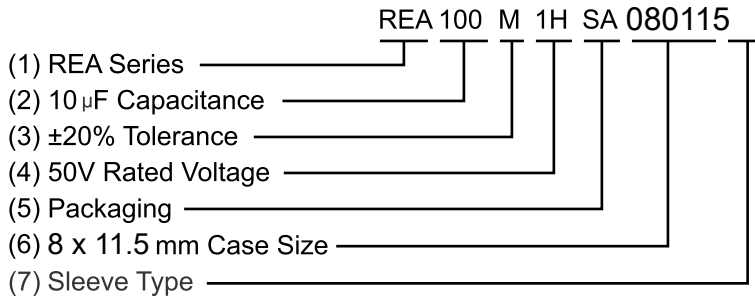

1. Series: REA

2. Capacitance: Rated capacitance in µF is represented by a three digit number. The first two digits are the significant figures of the nominal capacitance and the third digit indicates the number of zeros following these figures. The decimal point is represented by the capital letter R. Please refer to the following example.

µF	0.1	0.47	1	4.7	10	47	100	470	1000	4700	10000
Part Number	0R1	R47	010	4R7	100	470	101	471	102	472	103

3. Tolerance: (20% IS Typical)

Code	K	M	T	W
Tolerance	± 10%	± 20%	± 50% / -10%	± 100% / -10%

4. Rated Voltage: Voltage in volts (V) is represented by a two digit code showing the rated working voltage indicated as follows:

Voltage (WV)	6.3	10	16	25	35	40	50	63	80	100	160	200	250	350	400	450
Code	0J	1A	1C	1E	1V	1G	1H	1J	1K	2A	2C	2D	2E	2V	2G	2W

5. Lead Forming & Package

Code	Lead Description	Packaging
BC	Bending Cut	Bulk Packing
BK	Straight Lead	Bulk Packing
CC	Lead Cutting	Bulk Packing
FC	Lead Forming & Cutting	Bulk Packing
SD	Cathode Lead Beading	Bulk Packing
SF	Snap-in, Forming & Cutting	Bulk Packing
SA	Straight Lead	Tape & Ammo
TA	Lead Forming	Tape & Ammo
SR	Straight Lead	Tape & Reel
TR	Lead Forming	Tape & Reel

6. Can Size

Diameter (mm)x10 & Length (mm)x10. Can Size 063110, represents 6.3mm diameter by 11mm length.

7. Sleeve Type* = (Omit) PVC Sleeve

P = PET Sleeve

*Note: All standard RFE Aluminum Electrolytic Capacitors are Lead (Pb) free and RoHS compliant. PET sleeve is available for those companies that also require PVC free product.

LEADED TAPING & PACKAGING SPECIFICATIONS Taping Specification for Radial Lead Type

Fig. 1

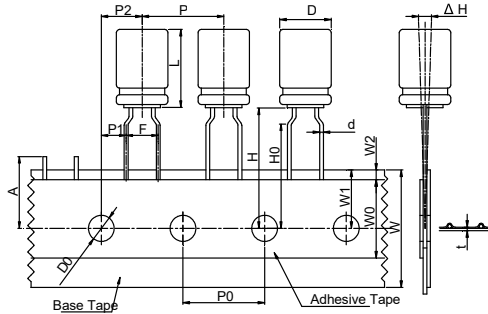

Fig. 2

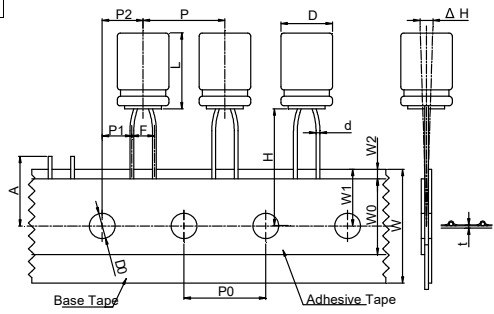

Fig. 3

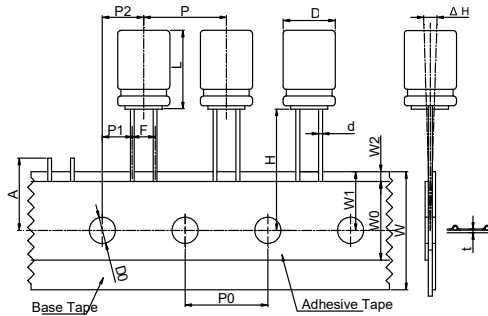
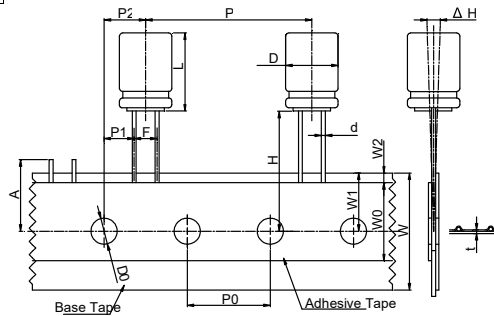
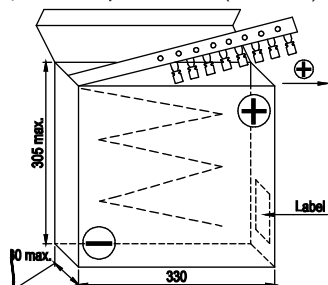

Fig. 4



Packing	TA, TR (Fig. 1)								SA, SR (Fig. 2, 3, 4)											
	L ≤ 7mm				L ≥ 7mm				L ≤ 7mm					L ≥ 7mm						
Symbol	3	4	5	6.3	8	5	6.3	8	3	4	5	6.3	8	5	6.3	8	Tol.	10	13	Tol.
d	0.4	0.45	0.5	0.5	0.5	0.5	0.5	0.6	0.4	0.45	0.45	0.45	0.45	0.5	0.5	0.6	± 0.05	0.6	0.6	± 0.05
F	5.0	5.0	5.0	5.0	5.0	5.0	5.0	5.0	2.5	2.5	2.5	2.5	3.5	2.5	2.5	3.5	-0.2/+0.8	5.0	5.0	-0.2/+0.8
P	12.7	12.7	12.7	12.7	12.7	12.7	12.7	12.7	12.7	12.7	12.7	12.7	12.7	12.7	12.7	12.7	± 1.0	12.7	25.4	± 1.0
P0	12.7	12.7	12.7	12.7	12.7	12.7	12.7	12.7	12.7	12.7	12.7	12.7	12.7	12.7	12.7	12.7	± 0.2	12.7	12.7	± 0.30
P2	6.35	6.35	6.35	6.35	6.35	6.35	6.35	6.35	6.35	6.35	6.35	6.35	6.35	6.35	6.35	6.35	± 1.0	6.35	6.35	± 1.3
P1	3.85	3.85	3.85	3.85	3.85	3.85	3.85	3.85	5.1	5.1	5.1	5.1	4.6	5.1	5.1	4.6	± 0.5	3.85	3.85	± 0.7
H	17.5	17.5	17.5	17.5	17.5	18.5	18.5	20.0	17.5	17.5	17.5	17.5	17.5	18.5	18.5	18.5	± 0.75	18.5	18.5	± 0.75
H0	16.0	16.0	16.0	16.0	16.0	16.0	16.0	--	--	--	--	--	--	--	--	--	± 0.5	--	--	± 0.5
W	18.0	18.0	18.0	18.0	18.0	18.0	18.0	18.0	18.0	18.0	18.0	18.0	18.0	18.0	18.0	18.0	± 0.5	18.0	18.0	± 0.5
W0	12.0	12.0	12.0	12.0	12.0	12.0	12.0	12.0	12.0	12.0	12.0	12.0	12.0	12.0	12.0	12.0	Min.	12.0	12.0	Min.
W1	9.0	9.0	9.0	9.0	9.0	9.0	9.0	9.0	9.0	9.0	9.0	9.0	9.0	9.0	9.0	9.0	± 0.5	9.0	9.0	± 0.5
W2	1.5	1.5	1.5	1.5	1.5	1.5	1.5	1.5	1.5	1.5	1.5	1.5	1.5	1.5	1.5	1.5	Max.	1.5	1.5	Max.
D0	4.0	4.0	4.0	4.0	4.0	4.0	4.0	4.0	4.0	4.0	4.0	4.0	4.0	4.0	4.0	4.0	± 0.2	4.0	4.0	± 0.2
t	0.7	0.7	0.7	0.7	0.7	0.7	0.7	0.7	0.7	0.7	0.7	0.7	0.7	0.7	0.7	0.7	± 0.2	0.7	0.7	± 0.2
ΔH	0	0	0	0	0	0	0	0	0	0	0	0	0	0	0	0	± 1.0	0	0	± 1.0
ε	1.0	1.0	1.0	1.0	1.0	1.0	1.0	1.0	1.0	1.0	1.0	1.0	1.0	1.0	1.0	1.0	Max.	1.0	1.0	Max.
A	11	11	11	11	11	11	11	11	11	11	11	11	11	11	11	11	Max.	11	11	Max.
Fig. No.	1	1	1	1	1	1	1	1	2	2	2	3	3	2	3	3		3	3,4	

Ammo pack box.(SA,TA) Reel pack box.(SR,TR)
10 Boxes per carton



Packaging Quantity

D	3	4	5	6.3	8	10	13
TA, SA	3000	2000	2000	2000	1000	500	250
TR, SR	3000	1500	1200	1000	800	500	500

NOTES:

- The above quantities are typical. Quantities may vary.
- The component will be oriented on the tape so that the positive lead is leading or the negative lead is leading, depending on the customer's request

RADIAL FORMING

Lead Forming & Cutting Specifications for Radial Type (Unit: mm)

Forming Method	Code	Shape	Dimensions																																																																																
Forming Cut (4 ~ 8)	FC		<table border="1"> <thead> <tr> <th>D x L</th> <th>d</th> <th>F</th> <th>F'</th> <th>H</th> </tr> </thead> <tbody> <tr><td>3 x 5</td><td>0.40</td><td>1.0</td><td>5.0</td><td>5.0</td></tr> <tr><td>4 x 5</td><td>0.45</td><td>1.5</td><td>5.0</td><td>5.0</td></tr> <tr><td>5 x 5</td><td>0.45</td><td>2.0</td><td>5.0</td><td>5.0</td></tr> <tr><td>6.3 ~ 8 x 5</td><td>0.45</td><td>2.5</td><td>5.0</td><td>5.0</td></tr> <tr><td>4 x 7</td><td>0.45</td><td>1.5</td><td>5.0</td><td>5.0</td></tr> <tr><td>5 x 7 ~ 11</td><td>0.5</td><td>2.0</td><td>5.0</td><td>5.0</td></tr> <tr><td>6 x 7 ~ 15</td><td>0.5</td><td>2.5</td><td>5.0</td><td>5.0</td></tr> <tr><td>8 x 7 ~ 9</td><td>0.5</td><td>3.5</td><td>5.0</td><td>5.0</td></tr> <tr><td>8 x 11.5 ~ 20</td><td>0.6</td><td>3.5</td><td>5.0</td><td>5.0</td></tr> <tr><td>10</td><td>0.6</td><td>5.0</td><td>-</td><td>4.5</td></tr> <tr><td>12.5</td><td>0.6</td><td>5.0</td><td>-</td><td>4.5</td></tr> <tr><td>16</td><td>0.8</td><td>7.5</td><td>-</td><td>4.5</td></tr> <tr><td>18</td><td>0.8</td><td>7.5</td><td>-</td><td>4.5</td></tr> <tr><td>22</td><td>1.0</td><td>10.0</td><td>-</td><td>4.5</td></tr> <tr><td>25</td><td>1.0</td><td>12.5</td><td>-</td><td>4.5</td></tr> </tbody> </table>	D x L	d	F	F'	H	3 x 5	0.40	1.0	5.0	5.0	4 x 5	0.45	1.5	5.0	5.0	5 x 5	0.45	2.0	5.0	5.0	6.3 ~ 8 x 5	0.45	2.5	5.0	5.0	4 x 7	0.45	1.5	5.0	5.0	5 x 7 ~ 11	0.5	2.0	5.0	5.0	6 x 7 ~ 15	0.5	2.5	5.0	5.0	8 x 7 ~ 9	0.5	3.5	5.0	5.0	8 x 11.5 ~ 20	0.6	3.5	5.0	5.0	10	0.6	5.0	-	4.5	12.5	0.6	5.0	-	4.5	16	0.8	7.5	-	4.5	18	0.8	7.5	-	4.5	22	1.0	10.0	-	4.5	25	1.0	12.5	-	4.5
D x L	d	F	F'	H																																																																															
3 x 5	0.40	1.0	5.0	5.0																																																																															
4 x 5	0.45	1.5	5.0	5.0																																																																															
5 x 5	0.45	2.0	5.0	5.0																																																																															
6.3 ~ 8 x 5	0.45	2.5	5.0	5.0																																																																															
4 x 7	0.45	1.5	5.0	5.0																																																																															
5 x 7 ~ 11	0.5	2.0	5.0	5.0																																																																															
6 x 7 ~ 15	0.5	2.5	5.0	5.0																																																																															
8 x 7 ~ 9	0.5	3.5	5.0	5.0																																																																															
8 x 11.5 ~ 20	0.6	3.5	5.0	5.0																																																																															
10	0.6	5.0	-	4.5																																																																															
12.5	0.6	5.0	-	4.5																																																																															
16	0.8	7.5	-	4.5																																																																															
18	0.8	7.5	-	4.5																																																																															
22	1.0	10.0	-	4.5																																																																															
25	1.0	12.5	-	4.5																																																																															
Cut (3 ~ 25)	CC																																																																																		
Bending Cut (5 ~ 25)	BC		<table border="1"> <thead> <tr> <th>D x L</th> <th>d</th> <th>F±0.5</th> </tr> </thead> <tbody> <tr><td>5 X 11</td><td>0.5</td><td>2.0</td></tr> <tr><td>6.3 X 11 ~ 15</td><td>0.5</td><td>2.5</td></tr> <tr><td>8 X 11.5 ~ 20</td><td>0.6</td><td>3.5</td></tr> <tr><td>10</td><td>0.6</td><td>5.0</td></tr> <tr><td>12.5</td><td>0.6</td><td>5.0</td></tr> <tr><td>16</td><td>0.8</td><td>7.5</td></tr> <tr><td>18</td><td>0.8</td><td>7.5</td></tr> <tr><td>22</td><td>1.0</td><td>10.0</td></tr> <tr><td>25</td><td>1.0</td><td>12.5</td></tr> </tbody> </table>	D x L	d	F±0.5	5 X 11	0.5	2.0	6.3 X 11 ~ 15	0.5	2.5	8 X 11.5 ~ 20	0.6	3.5	10	0.6	5.0	12.5	0.6	5.0	16	0.8	7.5	18	0.8	7.5	22	1.0	10.0	25	1.0	12.5																																																		
D x L	d	F±0.5																																																																																	
5 X 11	0.5	2.0																																																																																	
6.3 X 11 ~ 15	0.5	2.5																																																																																	
8 X 11.5 ~ 20	0.6	3.5																																																																																	
10	0.6	5.0																																																																																	
12.5	0.6	5.0																																																																																	
16	0.8	7.5																																																																																	
18	0.8	7.5																																																																																	
22	1.0	10.0																																																																																	
25	1.0	12.5																																																																																	
(10 ~ 25)	SD																																																																																		