

■ FEATURES

- A wide range of sizes (0201 to 2225)
- High capacitance in given case size
- Nickel Barrier Termination (pure Tin)
- High voltages, Automotive grade are available
- Soft Termination, see MA____S Series
- RoHS Compliant

■ DIMENSIONS

Size inches (mm)	Length (mm)	Width (mm)	Thickness Max (mm)
0201 (0603)	0.60	0.30	0.35
0402 (1005)	1.00	0.50	0.55
0603 (1608)	1.60	0.80	0.95
0805 (2012)	2.00	1.25	1.35
1206 (3216)	3.20	1.60	1.85
1210 (3225)	3.20	2.50	2.70
1808 (4520)	4.50	2.00	2.70
1812 (4532)	4.50	3.30	2.70
1825 (4563)	4.50	6.30	2.70
2220 (5750)	5.70	5.00	2.70
2225 (5763)	5.70	6.30	2.70

*Thicknesses noted are maximum. Thicknesses are less on low capacitance values.

*Add "S" after size code for soft terminations.

■ HOW TO MAKE PART NUMBER

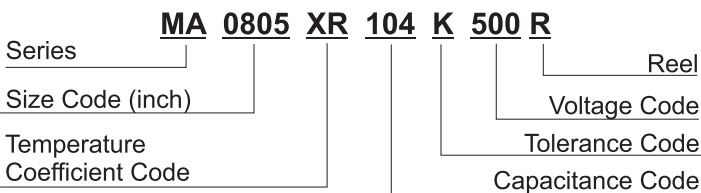

■ TOLERANCE CODE

Code	Tolerance
B	±0.1pF
C	±0.25pF
D	±0.5pF
G	±2%
J	±5%
K	±10%
M	±20%
Z	+80/-20%

■ GENERAL ELECTRICAL DATA

Dielectric	C0G/NPO	X7R	X5R	Y5V
Temperature Coefficient Code	CG	XR	X5R	YV
Tan δ°	Cap. <30pF: Q≥400+20°C Cap. ≥30pF: Q≥1000	Note 1 (on page 2)		
Operating Temperature	-55 to +125°C		-55 to +85°C	-25 to +85°C
Capacitance Characteristic	±30ppm / °C		±15%	+22% -82%

* Measured at the condition of 30~70% related humidity, apply 1.0±0.2Vrms, 1.0MHz±10%, at 25°C ambient temperature

** Preconditioning for Class II MLCC: Perform a heat treatment at 150±10°C for 1 hour, then leave in ambient condition for 24±2 hours before measurement.

GENERAL ELECTRICAL DATA

Note 1: X7R / X5R

Rated	D.F. ≤	Exception of D.F. ≤	
50V	≤2.50%	≤3%	0201 (50V), 0603≥0.047μF, 0805≥0.047μF, 1206≥0.047μF, 1210≥3.3μF, 1812≥10μF, 2220≥22μF
		≤5%	0201≥0.01μF, 1210≥4.7μF
		≤10%	0402≥0.1μF, 0603≥0.1μF, 0805≥1μF, 1206≥2.2μF, 1210≥10μF
35V	≤3.50%	≤10%	0402≥0.1μF, 0603≥0.1μF, 0805≥2.2μF, 1206≥2.2μF, 1210≥10μF
25V	≤3.50%	≤5%	0201≥0.01μF, 0805≥1μF, 1210≥10μF
		≤7%	0603≥0.33μF, 1206≥4.7μF
		≤10%	0201≥0.1μF, 0402≥0.1μF, 0603≥0.47μF, 0603≥0.047μF, 0805≥2.2μF, 1206≥6.8μF, 1210≥22μF
		≤12.50%	0402≥0.47μF
16V	≤3.50%	≤5%	0201≤0.01μF, 0402≥0.033μF, 0603≥0.15μF, 0805≥0.68μF, 1206≥2.2μF, 1210≥4.7μF
		≤10%	0201≥0.01μF, (0201/X7R≥0.022μF), 0402≥0.22μF, 0603≥0.68μF, 0805≥2.2μF, 1206≥4.7μF, 1210≥22μF
10V	≤5%	≤10%	0201≥0.01μF, 0402≥0.33μF (0402/X7R≥0.22μF), 0603≥0.33μF, 0805≥2.2μF, 1206≥2.2μF, 1206≥2.2μF
		≤15%	1201≥0.1μF, 0402≥1μF
6.3V	≤10%	≤15%	0201≥0.1μF, 0402≥1μF, 0603≥10μF, 0805≥4.7μF, 1206≥4.7μF, 1210≥100μF
		≤20%	0402≥2.2μF
4V	≤15%	---	----

COG/NPO: Typical Capacitance Change vs. Temperature

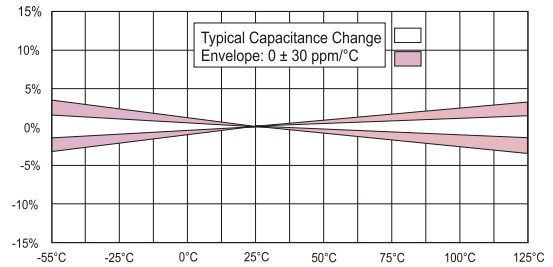

X7R: Typical Capacitance Change vs. Temperature

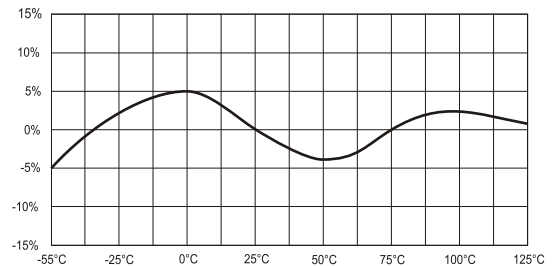

Note 1: Y5V

Rated	D.F. ≤	Exception of D.F. ≤	
≥50V	≤5%	≤7%	0603≥0.01μF, 0805≥0.47μF, 1206≥4.7μF
		≤12.50%	1210≥6.8μF
35V	≤7%	---	---
25V	≤5%	≤7%	0402≥0.047μF, 0603≥0.1μF, 0805≥0.33μF, 1206≥1μF, 1210≥4.7μF
		≤9%	0402≥0.068μF, 0603≥0.47μF, 0805≥0.33μF, 1206≥4.7μF, 1210≥22μF
16V (C<1.0μF)	≤7%	≤9%	0402≥0.068μF, 0603≥0.68μF
		≤12.50%	0402≥0.22μF
16V (C≥1.0μF)	≤9%	≤12.50%	0603≥2.2μF, 0805≥3.3μF, 1206≥10μF, 1210≥22μF, 1812≥47μF
10V	≤12.50%	≤20%	0402≥0.47μF
6.3V	≤20%	---	---

X5R: Typical Capacitance Change vs. Temperature

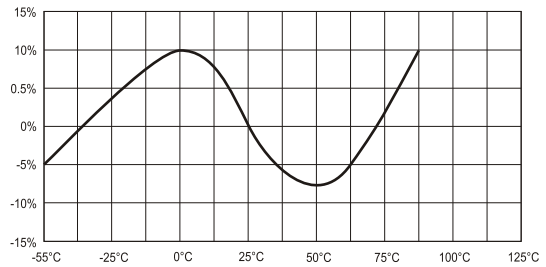

Y5V: Typical Capacitance Change vs. Temperature

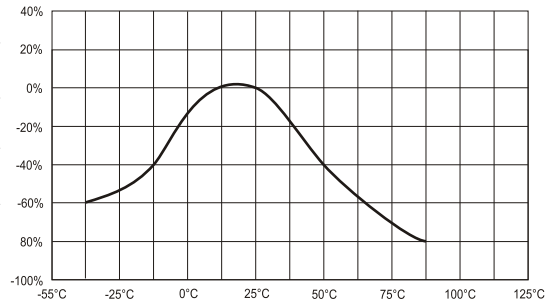

CAPACITANCE CODE EXAMPLES

Code	221	102	222	103	473	104	105	106
in pF	220	1,000	2,200	10,000	47,000	100,000	1,000,000	10,000,000
in μF	0.00022	0.001	0.0022	0.01	0.047	0.1	1	10

■ STANDARD VOLTAGES AND CAPACITANCE RANGES (pF)

Temperature Coefficient			COG/NPO	X7R	X5R	Y5V
Size Code	Voltage	Code	(CG)	(XR)	(X5R)	(YV)
0201	4V	040			10,000 ~ 470,000	
	6.3V	060		1,000 ~ 10,000	10,000 ~ 470,000	
	10V	100	0.10 ~ 120	1,000 ~ 22,000	1,000 ~ 220,000	
	16V	160	0.10 ~ 120	100 ~ 22,000	100 ~ 220,000	
	25V	250	0.10 ~ 560	100 ~ 10,000	100 ~ 100,000	
	50V/35V	500/350	0.10 ~ 150	100 ~ 1,000	100 ~ 10,000	
0402	6.3V	060		22,000 ~ 470,000	47,000 ~ 4,700,000	220,000 ~ 1,000,000
	10V	100	0.10 ~ 1,000	100 ~ 470,000	47,000 ~ 2,200,000	10,000 ~ 470,000
	16V	160	0.10 ~ 1,000	100 ~ 220,000	27,000 ~ 2,200,000	10,000 ~ 470,000
	25V	250	0.10 ~ 1,000	100 ~ 220,000	100,000 ~ 2,200,000	10,000 ~ 100,000
	35V	350			100,000 ~ 2,200,000	
	50V	500	0.10 ~ 1,000	100 ~ 100,000	220,000 ~ 470,000	10,000 ~ 33,000
0603	6.3V	060		270,000 ~ 680,000	220,000 ~ 10,000,000	2,200,000 ~ 4,700,000
	10V	100	0.30 ~ 10,000	100 ~ 2,200,000	220,000 ~ 4,700,000	10,000 ~ 2,200,000
	16V	160	0.30 ~ 10,000	100 ~ 2,200,000	220,000 ~ 2,200,000	10,000 ~ 1,000,000
	25V	250	0.30 ~ 12,000	100 ~ 1,000,000	100,000 ~ 1,000,000	10,000 ~ 680,000
	50V	500	0.30 ~ 12,000	100 ~ 1,000,000	220,000 ~ 1,000,000	10,000 ~ 470,000
	100V	101	0.47 ~ 1,000	100 ~ 68,000		
	200V	201	0.47 ~ 820	100 ~ 15,000		
	250V	251	0.47 ~ 820	100 ~ 15,000		
0805	6.3V	060		220,000 ~ 10,000,000	1,000,000 ~ 22,000,000	1,000,000 ~ 22,000,000
	10V	100	0.47 ~ 22,000	100 ~ 10,000,000	1,000,000 ~ 22,000,000	10,000 ~ 10,000,000
	16V	160	0.47 ~ 22,000	100 ~ 10,000,000	1,000,000 ~ 22,000,000	10,000 ~ 4,700,000
	25V/35V	250/350	0.47 ~ 22,000	100 ~ 4,700,000	1,000,000 ~ 22,000,000	10,000 ~ 2,200,000
	50V	500	0.47 ~ 22,000	100 ~ 2,200,000	1,000,000 ~ 10,000,000	10,000 ~ 1,000,000
	100V	101	0.47 ~ 27,000	100 ~ 470,000		
	200V	201	0.47 ~ 3,300	100 ~ 68,000		
	250V	251	0.47 ~ 3,300	100 ~ 33,000		
	500V	501	0.47 ~ 2,200	100 ~ 22,000		
	630V	631	0.47 ~ 2,200	100 ~ 22,000		
	1000V	102	1.50 ~ 330	100 ~ 8,200		
1206	6.3V	060			10,000,000 ~ 100,000,000	2,200,000 ~ 47,000,000
	10V	100	1.20 ~ 100,000	150 ~ 22,000,000	10,000,000 ~ 47,000,000	10,000 ~ 22,000,000
	16V	160	1.20 ~ 100,000	150 ~ 22,000,000	3,300,000 ~ 22,000,000	10,000 ~ 10,000,000
	25V	250	1.20 ~ 100,000	100 ~ 10,000,000	3,300,000 ~ 22,000,000	10,000 ~ 4,700,000
	50V/35V	500/350	0.47 ~ 100,000	100 ~ 4,700,000	3,300,000 ~ 10,000,000	10,000 ~ 2,200,000
	100V	101	0.47 ~ 15,000	100 ~ 2,200,000		
	200V	201	1.50 ~ 10,000	100 ~ 100,000		
	250V	251	1.50 ~ 10,000	100 ~ 100,000		
	500V	501	1.50 ~ 10,000	100 ~ 47,000		
	630V	631	1.50 ~ 10,000	100 ~ 47,000		
	1000V	102	1.50 ~ 1,200	100 ~ 22,000		
	1500V	152	1.50 ~ 470	100 ~ 4,700		
	2000V	202	1.50 ~ 470	100 ~ 3,300		
	3000 V	302	10 ~ 82			
1210	6.3V	060			47,000,000 ~ 100,000,000	47,000,000 ~ 100,000,000
	10V	100	10 ~ 33,000	1,000 ~ 820,000	22,000,000 ~ 100,000,000	100,000 ~ 47,000,000
	16V	160	10 ~ 33,000	1,000 ~ 22,000,000	3,300,000 ~ 47,000,000	100,000 ~ 22,000,000
	25V	250	10 ~ 68,000	220 ~ 22,000,000	2,200,000 ~ 22,000,000	100,000 ~ 680,000
	50V/35V	500/350	10 ~ 100,000	220 ~ 10,000,000	1,000,000 ~ 10,000,000	100,000 ~ 680,000
	100V	101	10 ~ 47,000	220 ~ 3,300,000		
	200V	201	10 ~ 33,000	220 ~ 680,000		
	250V	251	10 ~ 33,000	220 ~ 680,000		
	500V	501	10 ~ 18,000	220 ~ 150,000		
	630V	631	10 ~ 15,000	220 ~ 150,000		
	1000V	102	10 ~ 3,900	220 ~ 68,000		
	1500V	152	10 ~ 1,800	220 ~ 8,200		
	2000V	202	10 ~ 1,800	220 ~ 8,200		
	3000V	302	10 ~ 270			
	1808	6.3V	060			47,000,000 ~ 100,000,000
10V		100			22,000,000 ~ 47,000,000	
16V		160			3,300,000 ~ 47,000,000	
25V		250	2.2 ~ 39,000	150 ~ 22,000,000	22,000,000	
50V/35V		500/350	2.2 ~ 39,000	150 ~ 4,700,000	10,000,000	
100V		101	2.2 ~ 27,000	150 ~ 2,200,000		
200V		201	2.2 ~ 18,000	150 ~ 470,000		
250V		251	2.2 ~ 18,000	150 ~ 470,000		
500V		501	2.2 ~ 12,000	150 ~ 150,000		
630V		631	2.2 ~ 10,000	150 ~ 150,000		
1000V		102	2.2 ~ 3,300	150 ~ 56,000		
1500V		152	2.2 ~ 1,800	150 ~ 6,800		
2000V		202	2.2 ~ 1,800	150 ~ 6,800		
3000V		302	2.2 ~ 560	150 ~ 2,200		
4000V	402		150 ~ 1,000			

*Surface mount offerings continue to change, please contact RFE International, for values, sizes, and voltages not listed.

■ **STANDARD VOLTAGES AND CAPACITANCE RANGES (pF)**

Temperature Coefficient		COG/NPO	X7R	X5R	Y5V	
Size Code	Voltage	Code	(CG)	(XR)	(X5R)	(YV)
1812	6.3V	060			47,000,000 ~ 100,000,000	
	10V	100	10 ~ 33,000	1,000 ~ 22,000,000	22,000,000 ~ 47,000,000	100,000 ~ 680,000
	16V	160	10 ~ 33,000	1,000 ~ 22,000,000	22,000,000	100,000 ~ 680,000
	25V	160	10 ~ 150,000	270 ~ 22,000,000	10,000,000	100,000 ~ 680,000
	50V	200	10 ~ 150,000	270 ~ 4,700,000		100,000 ~ 680,000
	100V	101	10 ~ 100,000	270 ~ 2,200,000		
	200V	201	10 ~ 56,000	270 ~ 1,000,000		
	250V	251	10 ~ 56,000	270 ~ 1,000,000		
	500V	501	10 ~ 39,000	270 ~ 470,000		
	630V	631	10 ~ 33,000	270 ~ 220,000		
	1000V	102	10 ~ 5,600	270 ~ 100,000		
	1500V	152	10 ~ 3,300	270 ~ 10,000		
	2000V	202	10 ~ 3,300	270 ~ 10,000		
3000V	302	10 ~ 1,000	270 ~ 4,700			
4000V	402		270 ~ 1,800			
1825	25V	250	10 ~ 270,000	1,000 ~ 10,000,000		
	50V/35V	500/350	10 ~ 270,000	1,000 ~ 10,000,000		
	100V	101	10 ~ 120,000	1,000 ~ 10,000,000		
	200V	201	10 ~ 100,000	1,000 ~ 2,700,000		
	250V	251	10 ~ 100,000	1,000 ~ 2,700,000		
	500V	501	10 ~ 68,000	1,000 ~ 820,000		
	630V	631	10 ~ 68,000	1,000 ~ 820,000		
	1000V	102	10 ~ 12,000	1,000 ~ 330,000		
	1500V	152	10 ~ 8,200	1,000 ~ 56,000		
	2000V	202	10 ~ 8,200	1,000 ~ 56,000		
	3000V	302	10 ~ 2,700	1,000 ~ 18,000		
4000V	402		270 ~ 1,800			
2220	16V	160			47,000,000	
	25V	250	10 ~ 330,000	1,000 ~ 22,000,000	10,000,000 ~ 22,000,000	
	50V/35V	500/350	10 ~ 330,000	1,000 ~ 22,000,000	10,000,000	
	100V	101	10 ~ 130,000	1,000 ~ 10,000,000		
	200V	201	10 ~ 100,000	1,000 ~ 2,700,000		
	250V	251	10 ~ 100,000	1,000 ~ 2,700,000		
	500V	501	10 ~ 68,000	1,000 ~ 1,000,000		
	630V	631	10 ~ 56,000	1,000 ~ 1,000,000		
	1000V	102	10 ~ 12,000	1,000 ~ 390,000		
	1500V	152	10 ~ 8,200	1,000 ~ 56,000		
	2000V	202	10 ~ 8,200	1,000 ~ 56,000		
	3000V	302	10 ~ 2,700	1,000 ~ 18,000		
	4000V	402	27 ~ 330	270 ~ 1,800		
2225	25V	250	10 ~ 390,000	1,000 ~ 22,000,000		
	50V/35V	500/350	10 ~ 390,000	1,000 ~ 22,000,000		
	100V	101	10 ~ 220,000	1,000 ~ 10,000,000		
	200V	201	10 ~ 150,000	1,000 ~ 3,900,000		
	250V	251	10 ~ 150,000	1,000 ~ 3,900,000		
	500V	501	10 ~ 100,000	1,000 ~ 1,500,000		
	630V	631	10 ~ 82,000	1,000 ~ 1,500,000		
	1000V	102	10 ~ 12,000	1,000 ~ 390,000		
	1500V	152	10 ~ 10,000	1,000 ~ 100,000		
	2000V	202	10 ~ 10,000	1,000 ~ 56,000		
	3000V	302	10 ~ 3,300	1,000 ~ 18,000		
4000V	402	27 ~ 270	270 ~ 1,800			

*Surface mount offerings continue to change, please contact RFE International, for values, sizes, and voltages not listed.

■ SMD REEL TAPE SPECIFICATIONS

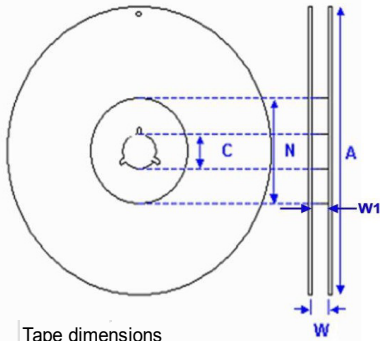

Reel dimensions

Size	0201, 0402, 0603, 0805, 1206, 1210	1808, 1812, 1825, 2220, 2225	
Reel size	7"(Standard)	13"(Speci)	7"
C	13.0	13.0	13.0
W₁	8.4+1.5	8.4+1.5	12.4
W	14.4max	14.4max	shall
A	178.0	330.0	178.0
N	60.0	100	60.0

Tape dimensions

Paper tape

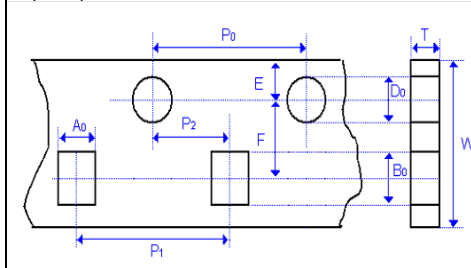

Embossed Plastic Tape

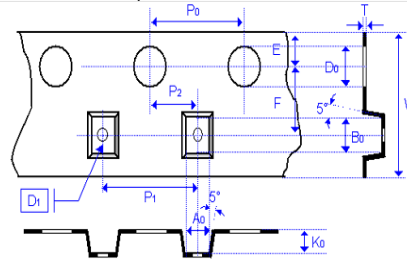

Size	0402	0603	0805	1206 & 1210	1808	1812					
Chip Thickness	0.5	0.5 ~ 0.8	0.5 ~ 0.8	1.25	0.80~0.85	0.95~1.25	1.6	1.25~1.6	2	1.25~1.6	2.5 ~ 2.8
A ₀	0.70±0.20	1.00	1.50±0.20	<1.80	2.00±0.10	<2.00	<2.50	<2.50	<2.50	<3.90	<3.90
B ₀	1.20±0.20	1.80±0.10	2.30±0.20	<2.70	3.50±0.50	<3.70	<4.00	<5.30	<5.30	<5.30	<5.30
T	≤0.80	0.95±0.05	0.95±0.05	0.23±0.05	0.95±0.05	0.23±0.05	0.23±0.05	0.25±0.05	0.25±0.05	0.25±0.05	0.25±0.05
K ₀	-	-	-	<2.50	-	<2.50	<2.50	<2.50	<2.50	<2.50	<3.00
W	8.00±0.10	8.00±0.10	8.00±0.10	8.00±0.10	8.00±0.10	8.00±0.10	8.00±0.10	12.00±0.2	12.00±0.2	12.00±0.2	12.00±0.2
P ₀	4.00±0.10	4.00±0.10	4.00±0.10	4.00±0.10	4.00±0.10	4.00±0.10	4.00±0.10	4.00±0.10	4.00±0.10	4.00±0.10	4.00±0.10
10xP ₀	40.00±0.10	40.00±0.2	40.00±0.20	40.00±0.2	40.00±0.2	40.00±0.2	40.00±0.2	40.00±0.2	40.00±0.2	40.00±0.2	40.00±0.2
P ₁	2.00±0.05	4.00±0.10	4.00±0.10	4.00±0.10	4.00±0.10	4.00±0.10	4.00±0.10	4.00±0.10	4.00±0.10	8.00±0.10	8.00±0.10
P ₂	2.00±0.05	2.00±0.05	2.00±0.05	2.00±0.05	2.00±0.05	2.00±0.05	2.00±0.05	2.00±0.05	2.00±0.05	2.00±0.05	2.00±0.05
D ₀	1.50 +0.10/-0	1.50	1.50 +0.10/-0	1.50	1.50	1.50	1.50	1.50	1.50	1.50	1.50
D ₁	-	-	-	1.00±0.10	-	1.00±0.10	1.00±0.10	1.50±0.10	1.50±0.10	1.50±0.10	1.50±0.10
E	1.75±0.05	1.75±0.05	1.75±0.05	1.75±0.10	1.75±0.10	1.75±0.10	1.75±0.10	1.75±0.10	1.75±0.10	1.75±0.10	1.75±0.10
F	3.50±0.05	3.50±0.05	3.50±0.05	3.50±0.05	3.50±0.05	3.50±0.05	3.50±0.05	5.50±0.05	5.50±0.05	5.50±0.05	5.50±0.05

1825		2220		2225	
1.6 ~ 2	2.5 ~ 2.8	1.4 ~ 2	2.5 ~ 2.8	1.6 ~ 2	2.5 ~ 2.8
<6.80	<6.80	<5.80	<6.80	<6.80	<6.80
<5.30	<5.30	<6.50	<6.50	<6.50	<6.50
0.30±0.10	0.30±0.10	0.30±0.10	0.30±0.10	0.30±0.10	0.30±0.10
<2.50	<3.10	<2.50	<3.10	<2.50	<3.10
12.00±0.2	12.00±0.2	12.00±0.2	12.00±0.2	12.00±0.2	12.00±0.2
4.00±0.10	4.00±0.10	4.00±0.10	4.00±0.10	4.00±0.10	4.00±0.10
40.00±0.2	40.00±0.2	40.00±0.2	40.00±0.2	40.00±0.2	40.00±0.2
8.00±0.10	8.00±0.10	8.00±0.10	8.00±0.10	8.00±0.10	8.00±0.10
2.00±0.05	2.00±0.05	2.00±0.05	2.00±0.05	2.00±0.05	2.00±0.05
1.50	1.50	1.50	1.50	1.50	1.50
1.50±0.10	1.50±0.10	1.50±0.10	1.50±0.10	1.50±0.10	1.50±0.10
1.75±0.10	1.75±0.10	1.75±0.10	1.75±0.10	1.75±0.10	1.75±0.10
5.50±0.05	5.50±0.05	5.50±0.05	5.50±0.05	5.50±0.05	5.50±0.05

Size code	Nominal Thickness, (mm)	Paper tape		Plastic tape	
		7" reel	13" reel	7" reel	13" reel
0402	0.5	10,000	50,000	-	-
0603	0.5	4,000	15,000	-	-
	0.8	4,000	15,000	-	-
0805	0.50 ~ 0.85	4,000	15,000	-	-
	1.25	-	-	3,000	10,000
1206 & 1210	0.80 ~ 0.85	4,000	15,000	-	-
	0.95 ~ 1.25	-	-	3,000	10,000
	1.6	-	-	2,000	10,000
1808	1.25	-	-	2,000	10,000
	1.6	-	-	2,000	8,000
	2	-	-	1,000	6,000
1812 & 1825	1.25	-	-	1,000	5,000
	1.6 ~ 2	-	-	1,000	-
	2.5 ~ 2.8	-	-	500	-
2220 & 2225	1.6 ~ 2	-	-	1,000	-
	2.5 ~ 2.8	-	-	500	-