

INTRODUCTION

The RMT series are thin film resistors. They feature a lower temperature coefficient than standard thick film types and are ideal for use in applications where temperature stability is important. These resistors are lead free.

CONSTRUCTION

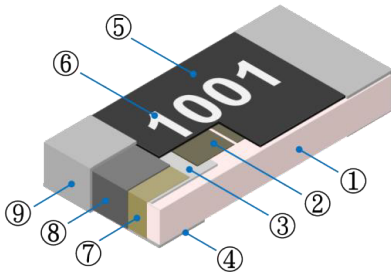

① Alumina Substrate	④ Bottom Inner Electrode	⑦ Side Inner Electrode
② Resistive Layer	⑤ Protective Overcoat	⑧ Nickel Barrier
③ Top Inner Electrode	⑥ Marking	⑨ Solder coating (Sn)

FEATURES

- Tolerance to $\pm 0.1\%$
- Low TCR to $\pm 10 \text{ ppm}/^\circ\text{C}$
- Halogen free and lead free
- See RMTUH12 for Triple Power
- Add Suffix Q for AECQ200 Type

DIMENSIONS

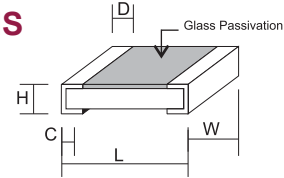

Size Code	Max. Dimension (mm)				
	L	W	H	C	D
RMT02 (0201)	0.60 \pm 0.05	0.30 \pm 0.05	0.23 \pm 0.05	0.15 \pm 0.05	0.12 \pm 0.05
RMT04 (0402)	1.00 \pm 0.20	0.50 \pm 0.15	0.30 \pm 0.05	0.20 \pm 0.10	0.20 \pm 0.10
RMT06 (0603)	1.60 \pm 0.20	0.80 \pm 0.15	0.40 \pm 0.10	0.30 \pm 0.20	0.30 \pm 0.15
RMT10 (0805)	2.00 \pm 0.20	1.25 \pm 0.20	0.50 \pm 0.15	0.35 \pm 0.15	0.35 \pm 0.15
RMT12 (1206)	3.20 \pm 0.20	1.60 \pm 0.20	0.55 \pm 0.15	0.45 \pm 0.20	0.45 \pm 0.20
RMT25 (1210)	3.20 \pm 0.20	2.50 \pm 0.20	0.55 \pm 0.15	0.50 \pm 0.20	0.50 \pm 0.20
RMT50 (2010)	5.00 \pm 0.20	2.50 \pm 0.20	0.55 \pm 0.10	0.60 \pm 0.20	0.60 \pm 0.20
RMT75 (2512)	6.30 \pm 0.20	3.20 \pm 0.20	0.55 \pm 0.10	0.60 \pm 0.20	0.60 \pm 0.20

RATINGS & RESISTANCE RANGE

Type	Rated Power at 70°C	Max. Working Voltage	Max. Overload Voltage	T.C.R. (PPM/C)	Resistance Range			
					B($\pm 0.1\%$)	C($\pm 0.1\%$)	D($\pm 0.5\%$)	F($\pm 1\%$)
RMT02 (0201)	0.05W	25V	50V	± 10 & ± 15	10 Ω - 5.1K Ω			
				± 25 & ± 50	10 Ω - 82K Ω			
RMT04 (0402)	0.063W	25V	50V	± 10 & ± 15	10 Ω - 68K Ω			
				± 25 & ± 50	4.7 Ω - 220K Ω	2.49 Ω - 220K Ω		
RMT06 (0603)	0.1W	75V	150V	± 10 & ± 15	10 Ω - 332K Ω			
				± 25 & ± 50	4.7 Ω - 680K Ω	2.49 Ω - 680K Ω		
RMT10 (0805)	0.125W	200V	300V	± 10 & ± 15	10 Ω - 680K Ω			
				± 25 & ± 50	4.7 Ω - 1M Ω	2.49 Ω - 1.0M Ω		
RMT12 (1206)	0.25W	200V	400V	± 10 & ± 15	10 Ω - 1M			
				± 25 & ± 50	4.7 Ω - 1.5M Ω	2.49 Ω - 1.5K Ω		
RMT25 (1210)	0.25W			± 10 & ± 15	10 Ω - 100K Ω			
				± 25 & ± 50	4.7 Ω - 100K Ω	2.49 Ω - 100K Ω		
RMT50 (2010)	0.5W			± 10 & ± 15	10 Ω - 100K Ω			
				± 25 & ± 50	4.7 Ω - 100K Ω	2.49 Ω - 100K Ω		
RMT75 (2512)	0.75W	± 10 & ± 15	10 Ω - 100K Ω					
		± 25 & ± 50	4.7 Ω - 100K Ω	2.49 Ω - 100K Ω				

PART NUMBER EXAMPLE

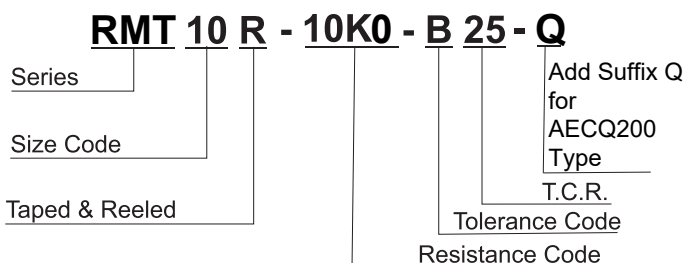

RESISTANCE CODE

Ohms	10	100	1.5K	15K	1M
Code	10R0	100R	1K50	15K0	1M00

TOLERANCE CODE

Tolerance	$\pm 0.1\%$	$\pm 0.25\%$	$\pm 0.5\%$	$\pm 1\%$
Code	B	C	D	F

■ **PERFORMANCE CHARACTERISTICS**

■ **POWER DERATING CURVE**

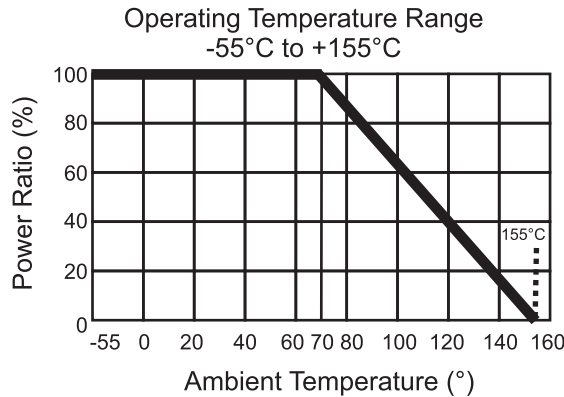

Power rating or current rating is in the case based on continuous full-load at ambient temperature of 70°C. For operation at ambient temperature in excess of 70°C, the load should be derated in accordance with figure of derating Curve.

■ **VOLTAGE RATING OR CURRENT RATING**

Resistance Range: ≥1Ω

Rated Voltage: The resistor shall have a DC continuous working voltage or a RMS AC continuous working voltage at commercial-line frequency and wave form corresponding to the power rating, as determined formula as follows:

$$E = \sqrt{P \times R}$$

E = Rated Voltage (V)

P = Power Rating (W)

R = Nominal Resistance (Ω)

■ **OPERATION AND STORAGE TEMPERATURE**

TYPE	MIN	MAX
Operation temperature	-55°C	70°C
Storage temperature	20°C	30°C
Storage humidity	30%	70°C

■ **SOLDERING PROFILE**

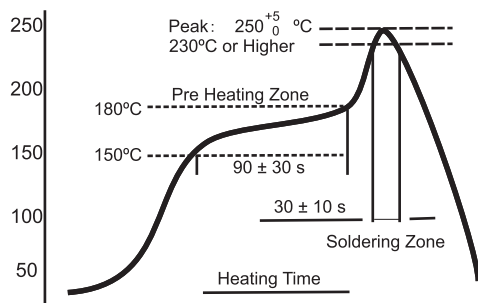

■ TEST PROCEDURES & REQUIREMENTS

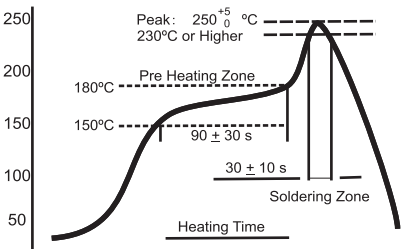
Test Item	Test Method	Procedure	Requirements
Temperature Coefficient of Resistance (T.C.R.)	JIS C 5201-1 Clause 4.8	-55°C ~ +155°C, 20°C is the reference temperature	Refer to Ratings
Short Time Overload	JIS C 5201-1 Clause 4.13	General: 2.5 times RCWV or Max. Overload voltage for 5 seconds High Power: 2.5 times RCWV or Max. Overload voltage for 2 seconds	±1: ±(1.0%+0.05Ω) ±5: ±(2.0%+0.1Ω)
IR Reflow	Sony SS-00254	 <p>The graph shows a temperature profile for IR reflow. The y-axis is temperature in °C (50 to 250) and the x-axis is heating time. Key points include: a pre-heating zone at 180°C, a dwell at 150°C for 90 ± 30 s, a peak at 250 ± 5 °C (230°C or higher), and a soldering zone at 30 ± 10 s.</p>	±1: ±(1.0%+0.05Ω) ±5: ±(2.0%+0.1Ω)
Leaching	Sony SS-00254-9	260 ±5°C for 30 seconds	> 95% Coverage
Soldering Heat	JIS C 5201-1 Clause 4.13	260 ±5°C for 10 seconds	±1: ±(0.5%+0.05Ω) ±5: ±(1.0%+0.05Ω)
Temperature Cycling	JIS C 5201-1 Clause 4.19	-55°C ~ +155°C, 5 cycles	0.1% ' 0.5% ' 1% ±(0.5%+0.05Ω) 2% ' 5% ±(1.0%+0.1Ω)
Electric Iron	Sony SS-00254-5	Preheating temperature: 350 ± 5°C Electric Iron preheating time: 3 +1/-0 sec.	±1: ±(0.5%+0.05Ω) ±5: ±(1.0%+0.05Ω)
Resistance to Solvent	JIS C 5201-1 Clause 4.29	The tested resistor be immersed into isopropyl alcohol of 20~25°C for 60 seconds. Then the resistor is left in the room for 48 hours.	±1: ±(0.5%+0.05Ω) ±5: ±(1.0%+0.05Ω)
Load Life in Humidity	JIS C 5201-1 Clause 4.24	40 ± 2°C, 90~95% R.H. or Max. working voltage for 1000 hours with 1.5 hrs "ON" and 0.5hr "OFF".	0.1% ' 0.5% ' 1% ±(0.5%+0.05Ω) 2% ' 5% ±(3.0%+0.1Ω)
Load Life (Endurance)	JIS C 5201-1 Clause 4.25	70 ± 2°C, or Max. working voltage for 1000 hours with 1.5 hrs "ON" and 0.5hr "OFF".	0.1% ' 0.5% ' 1% ±(1.0%+0.05Ω) 2% ' 5% ±(3.0%+0.1Ω)
Terminal Bending Strength	JIS C 5201-1 Clause 4.33	Bend once for 5 seconds RM Series 0402, 0603, 0805 = 5mm RM Series 1206, 1210, 1812 = 3mm RM Series 1218, 2010, 2512 = 2mm	±1: ±(1.0%+0.05Ω) ±5: ±(1.0%+0.05Ω)
Insulation Resistance	JIS C 5201-1 Clause 4.6	Max Overload Voltage for 1 min.	≥ 10G

■ **PACKAGE & DIMENSION**

Unit:mm

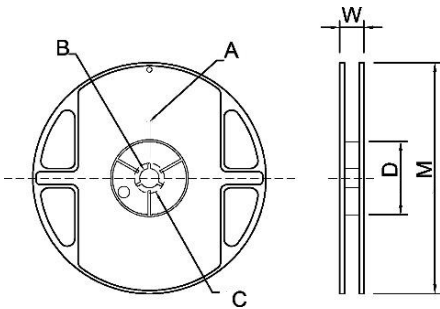

Size	Package Q'ty	A	B	C	D	W	M
RMT02(0201) RMT04(0402)	7" 10K/reel	2.0±0.5	13.5±1.0	21±1.0	60±1.0	11.5±2.0	178±2.0
RMT06(0603)	7" 5K/reel	2.0±0.5	13.5±1.0	21±1.0	60±1.0	11.5±2.0	178±2.0
RMT10(0805)	10" 10K/reel	2.0±0.5	13.5±1.0	21±1.0	100±1.0	11.5±2.0	254±2.0
RMT12(1206)	13" 20K/reel	2.0±0.5	13.5±1.0	21±1.0	100±1.0	11.5±2.0	330±2.0
RMT25(1210)	7" 5K/reel	2.0±0.5	13.5±1.0	21±1.0	60±1.0	11.5±2.0	178±2.0
RMT50(2010)	7" 4K/reel	2.0±0.5	13.5±1.0	21±1.0	60±1.0	16.0±2.0	178±2.0
RMT75(2512)							

■ **TAPING SPECIFICATION**

Paper Type
(P= 2.0 ± 0.1)

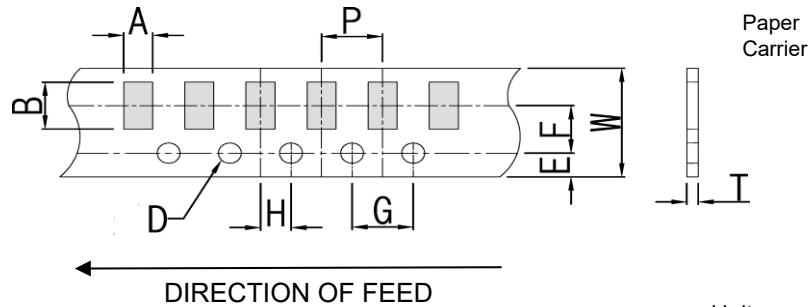

Unit:mm

Size	A	B	W	E	F	G	H	T	D
RMT02(0201)	0.45±0.10	0.75±0.10	8.0±0.20	1.75±0.10	3.5±0.05	4.0±0.10	2.0±0.05	0.35±0.10	1.50±0.10
RMT04(0402)	0.70±0.10	1.20±0.10	8.0±0.20	1.75±0.10	3.5±0.05	4.0±0.10	2.0±0.05	0.45±0.10	1.50±0.10
RMT06(0603)	1.05±0.20	1.80±0.20	8.0±0.20	1.75±0.10	3.5±0.05	4.0±0.10	2.0±0.05	0.60±0.10	1.50±0.10
RMT10(0805)	1.55±0.20	2.30±0.20	8.0±0.20	1.75±0.10	3.5±0.05	4.0±0.10	2.0±0.05	0.75±0.10	1.50±0.10
RMT12(1206)	1.90±0.20	3.50±0.20	8.0±0.20	1.75±0.10	3.5±0.05	4.0±0.10	2.0±0.05	0.75±0.10	1.50±0.10
RMT25(1210)	2.85±0.20	3.50±0.20	8.0±0.20	1.75±0.10	3.5±0.05	4.0±0.10	2.0±0.05	0.75±0.10	1.50±0.10

Embossed Type
(P= 4.0 ± 0.1)
(2W.P= 8.0 ± 0.2)

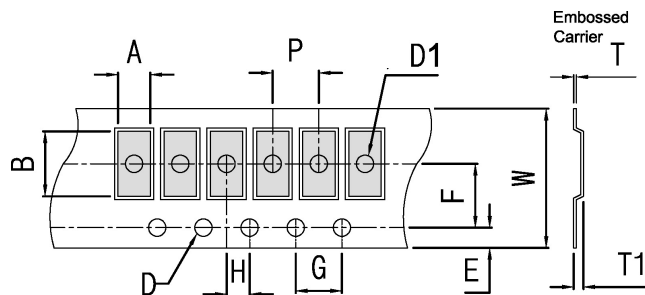

Unit:mm

Size	A	B	W	E	F	G	H	T	D	D1	T1
RMT50(2010)	2.80±0.20	5.60±0.20	12±0.10	1.75±0.10	5.5±0.05	4.0±0.10	2.0±0.05	0.23±0.10	1.50±0.10	1.50±0.10	0.85±0.15
RMT75(2512)	3.30±0.20	4.60±0.20	12±0.10	1.75±0.10	5.5±0.05	4.0±0.10	2.0±0.05	0.23±0.10	1.50±0.10	1.50±0.10	0.85±0.15